

Natural 7 Wood Pellet Fire Owners & Installation Manual

PLEASE READ THIS ENTIRE MANUAL BEFORE INSTALLATION, AND USE OF THIS WOOD PELLET FIRE.
FAILURE TO FOLLOW THESE INSTRUCTIONS COULD RESULT IN PROPERTY DAMAGE, BODILY INJURY,
OR EVEN DEATH.

Contact your local building or fire official about restrictions and installation requirement in your area.

ATTENTION

*If you are a not a registered pellet fire installer, and do not have legitimate access to the necessary passwords to install and program the Natural 7 Wood Pellet Fire, you **MUST NOT** install or attempt to install this fire.*

The Natural 7 Wood Pellet Fire requires technical programming and individualised air pressure adjustments to ensure it will operate safely and efficiently, and to avoid possible damage to the fire or the home.

Installation of the Natural 7 Wood Pellet Fire by a non-registered installer will void the warranty, and may result in your local authority refusing to approve the necessary permits.

If you require a registered Pellet Fire Solutions Installer, please contact us directly on info@pelletfiresolutions.co.nz



Owner's section - Table of Contents

| | | |
|-------------|--|-----------|
| 1. | Introduction..... | 5 |
| 1.1 | Specifications..... | 5 |
| 2. | Safety Warnings & Recommendations..... | 6 |
| 2.1 | Installation..... | 6 |
| 2.2 | Deciding where to locate your wood pellet burning fire..... | 7 |
| 2.3 | Ash..... | 7 |
| 2.4 | Clinkering..... | 7 |
| 2.5 | Filling Fuel Hopper..... | 7 |
| 2.6 | Flammable Liquids..... | 8 |
| 2.7 | Operating Instructions..... | 8 |
| 2.8 | Safety Devices..... | 8 |
| 2.9 | Responsibility..... | 8 |
| 2.10 | Spare Parts..... | 8 |
| 3. | What are Wood Pellets?..... | 9 |
| 4. | The Components of the Stove..... | 9 |
| 4.1 | Pellet Combustion..... | 10 |
| 5. | Maintenance and Cleaning..... | 11 |
| 5.1 | Cleaning the surfaces..... | 11 |
| 5.2 | Automatic cleaning system..... | 11 |
| 5.3 | Cleaning the Ash Drawer..... | 12 |
| 5.4 | Cleaning the combustion chamber..... | 12 |
| 5.5 | Cleaning the Flue..... | 12 |
| 5.6 | Acess to the inspection hatches for cleaning the smoke..... | 12 |
| 5.7 | Frequency of Component Cleaning..... | 13 |
| 5.8 | How to load Pellets..... | 14 |
| 5.9 | How to remove the flame trap..... | 14 |

| | | |
|-----------|--|-----------|
| 6. | Operating your Pellet Fire..... | 15 |
| 6.1 | Preliminary Operation..... | 15 |
| 6.2 | Description of Handheld Set..... | 15 |
| 6.3 | Handheld Touch Radio Initialization..... | 16 |
| 6.4 | Description of the Display..... | 16 |
| 6.5 | Time and Date Settings..... | 17 |
| 6.6 | Loading the Auger..... | 18 |
| 6.7 | Setting Operating Temperature and Power..... | 19 |
| 6.8 | Turning the Device on..... | 19 |
| 6.9 | Operating Phases of the Stove..... | 20 |
| 6.9.1 | Alarms | 28 |
| 7. | Maintenance Record..... | 30 |
| 8. | Warranty Information..... | 31 |
| 8.1 | Warranty Coverage..... | 31 |
| 8.2 | Warranty Period..... | 31 |
| 8.3 | Warranty Exclusions..... | 32 |
| 9. | Proof of Purchase/Warranty..... | 33 |

1. Introduction

This manual is designed for both the technician and the home owner.

Please read this entire manual before installing or operating your Ravelli Natural 7 Freestanding Wood Pellet Burning Stove. Failure to follow these instructions may result in property damage, bodily injury or even death. Any unauthorized modification of the appliance, or use of replacement parts not recommended by the manufacturer is prohibited. All national and local regulations shall be complied with when installing this appliance. Your local Pellet Fire Solutions dealer will be happy to assist you in obtaining information with regards to your local building codes and installation restrictions.

1.1 Specifications

1.1.1 Rating label Location

Ravelli Natural 7 Freestanding: The rating label is located on the back of the unit.

* Note: Consumption will vary with the type of fuel used.

| Classification | Testing Standard | Description |
|--|---|--|
| Class I IP-20 | Efficiency: AS/NZS 5078:2007 Appliance: AS/NZS 4866:2007 | Residential Wood Pellet Stove |
| Voltage 220- 240 Volt | Current: 2.92 —3.18 Amps | Frequency: 50Hz |
| Max Power Requirement 280 watts | Unit with full hopper: 158kg | Hopper Capacity: 18kg |
| Mean Flue Gas Temp — High: 139 degrees | Mean Flue Gas Temp- Medium: 112 degrees | Mean Flue Gas Temp- Low: 84 degrees |
| Fuel Consumption — High: 1.5 kg per hour | Fuel Consumption — Medium: 1.2kg per hour | Fuel Consumption — Low: 0.95 kg/W |
| Heat/Power Output — High: 6.8kw | Heat/Power Output — Medium: 5.5kw | Heat/Power Output — Low: 4.3kw |
| Average Particular Emissions (dry weight) 0.26 gms per kg | Average Emissions Rate 15mg/MJ | Average Efficiency 86% |
| Gross Calorific Value of pellets (dry weight) 20.1MJ/kg | Fuel Type: Wood pellets —6mm dia, - complying with draft standard AS/NZS 4014.6 2008 | |

IMPORTANT: The above values were found during testing and may vary with the fuel type, climate and installation style.

2. Safety Warnings & Recommendations

Pellet quality is important, please read the following:

Your pellet heater has been designed to burn ¼" (6mm) diameter wood pellets, manufactured to the AS/NZS 4014.6 only.

DO NOT use this appliance as an incinerator.

DO NOT use unsuitable and non recommended fuels, including liquid fuels, as this will void any warranties stated in the manual.

The performance of your pellet stove is greatly affected by the type and quality of wood pellets being burned. As the heat output of various quality wood pellets differs, so will the performance and heat output of the pellet stove.

Caution: It is important to select and use only pellets that are dry and free of dirt, or any impurities such as high salt content. Wood pellets manufactured to the AS/NZS 4014.6 standard are recommended. Dirty fuel will adversely affect the operation and performance of the unit and will void the warranty. The Pellet Fuel Industries (PFI) has established standards for wood pellet manufacturers. We recommend the use of pellets that meet or exceed these standards. Ask your dealer for a recommended pellet type.

2.1 Installation

The stove must be installed and tested by specialised personnel approved by Pellet Fire Solutions. Please read this manual before installing or operating the stove. If you require further information, please contact your Pellet Fire Solutions dealer. Installation must be performed by authorized personnel, who must give the purchaser a declaration of conformity of the appliance, and who will assume all responsibility for the final installation and consequent correct functioning of the product installed. It is also necessary to take into consideration all the laws and national, regional, provincial and local regulations present in the country in which the appliance has been installed. In the event of failure to respect these precautions, Pellet Fire Solutions declines all responsibility.

IMPORTANT:

- The place of installation of the stove must comply with local & national regulations. The stove must be fuelled only with quality pellets manufactured to standard AS/NZS4014.6. The stove cannot operate with traditional wood.
- The stove must not be used as an incinerator.
- Before connecting the stove electrically, the connection of the exhaust spigot must be completed (specifically for pellet stoves, not made from aluminum) with the flue. (All flue joins must be sealed with maniseal exhaust cement).
- The protection grill inside the pellet tank must never be removed.
- There must be sufficient circulation of air in the room where the stove is installed. Never open the door of the stove whilst it is functioning.
- When the stove is operating, the surfaces, the glass, the handle and the pipes become overheated: during functioning, these parts must only be touched with the adequate protection.
- Do not light the stove without having first performed the daily inspection as described in the MAINTENANCE & CLEANING chapter of this manual (see page 11).
- Scrupulously follow the maintenance program.
- Do not turn the stove off by disconnecting the electricity mains supply (use the remote control).

- Do not clean the stove until the structure and the ashes have cooled down completely. Carry out all operations with maximum safety.

Natural 7 should be installed in a centrally located position within the home. This will assist the appliance to perform to the level required. As the Natural 7 heats space by convecting air across the top of the unit, the heater should face the majority of the area to be heated.

Natural 7 requires a power source to function. This is standard mains feed 240v plug - if this is unavailable in close proximity, a grounded extension lead may be used.

Natural 7 is to be installed on a non-combustible surface, which must have a forward projection of a minimum of 150mm from the glass door.

Please check all clearances to combustibles as listed on page 37 and page 38 of this Owner's/ Technical manual.

In accordance with the requirements of AS/NZS 2918:2001, Natural 7 must be secured by seismic restraint.

2.2 Deciding where to locate your wood pellet burning stove

1. Do not install the pellet stove in a bedroom or room where people sleep.
2. Locate the pellet stove in a large and open room that is centrally located in the house. This will optimise heat circulation.
3. Check clearances to combustibles (refer page 37).

2.3 Ash

The ash content of the fuel and operation of your stove will directly determine the frequency of cleaning. The use of high ash fuels may result in the stove needing to be cleaned daily. A low ash fuel may allow longer intervals between cleaning.

2.4 Clinkering

Clinkers are silica (sand) or other impurities in the fuel that will form a hard mass during the burning process. This hard mass will block the air flow through the burn pot liner, and affect the performance of the stove. Any fuel, even approved types, may clinker. Check the burn pot liner daily to ensure that the holes are not blocked with clinkers. Refer to the Routine Cleaning and Maintenance section.

2.5 Filling Fuel Hopper

Check hopper for foreign objects, then empty the bag of pellets into the hopper. **DO NOT OVER FILL**, as miscellaneous pellets could smoke if left to rest on an operating stove.

Store pellets at least one metre (1m) away from the pellet stove.

Warning: parts of the appliance, especially the external surfaces, will be hot to touch when in operation so use due care.

2.6 Flammable Liquids

Never use gasoline, gasoline —type lantern fuel, kerosene, charcoal lighter fluid or similar liquids to start or “freshen” up a fire in the stove. Keep all such liquids well away from the stove while it is use.

2.7 Operating Instructions

The stove is completely automated and will self-regulate the ignition phase, five levels of power and the switching off phase, guaranteeing safe functioning. The burn pot used for combustion allows most of the ashes produced by the combustion of the pellets to fall into the collection drawer. However, it is recommended that you check the burn pot every day, as not all pellets have high standards of quality, and could leave residue that is difficult to remove. The glass has special air circulation for self-cleaning, however, a slight greyish film cannot be avoided after a few hours of functioning. Pellets with a diameter of 6mm, manufactured to the AS/NZ4014.6 or higher must be used with the stove.

2.8 Safety Devices

The stove is fitted with a sophisticated safety systems so that, in the case of breakage of one of the individual parts, or defects in the flue, no damage will be caused to the stove and the room in which it is installed. In any case, when a problem arises, the pellets stop falling immediately and the switch off phase is activated. The corresponding alarm will be shown on the display. The details can be seen in the chapter on the alarms (see page 28).

2.9 Responsibility

Pellet Fire Solutions declines all responsibility, both civil and criminal, with the delivery of this manual, for any accidents deriving from partial or total failure, to observe the instructions it contains.

Pellet Fire Solutions declines all responsibility deriving from the improper use of the stove, from its incorrect use by the user, by unauthorised modifications and/or repairs, or from the use of spare parts which are not original. The manufacturer declines all direct, civil or criminal responsibility due to:

- Poor maintenance.
- Failure to observe the instructions in the manual.
- Use not compliant with the safety instructions.
- Installation that is not compliant with the regulations in force in the country.
- Installation by personnel who are not qualified or authorised.
- Modifications and repairs that are not authorized by the manufacturer.
- Use of spare parts that are not original.
- Exceptional events.

2.10 Spare Parts

Use original spare parts only. Do not wait for the components to be worn before replacing them. Replace a worn component before it is completely broken, to prevent any accidents caused by the sudden breakage of components. Perform the periodic maintenance checks as described in the dedicated chapter on “Maintenance and Cleaning” on page 9.

3. What are Wood Pellets?

Wood pellets are made from sawdust and wood shavings. The material used cannot contain any foreign substance such as glue, varnish or synthetic substances. Subjecting it to high pressure, the wood is pressed through a plate with holes, and due to the high pressure, the sawdust is heated activating the natural binders of the wood. Thus, the pellets keep their shape even without the addition of bonding substances. The density of the wood pellet varies according to the type of wood and can be 1.5 —twice greater than that of natural wood. The diameter of the cylindrical rods is 6-10 mm and their length can vary between 10 and 50 mm. Their weight is equal to about 650 kg/m. Due to the low content of water (approx 8%) they have a high energy content. The standards AS/NZS4014.6 define the quality of the pellets:

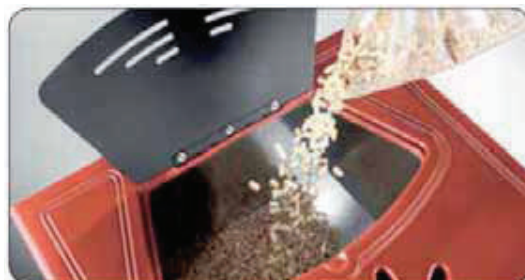

Do not put the bag of pellets on the cast parts during the loading operations.

The pellets must be transported and stored in a dry place. They swell on contact with any moisture and cannot be used. They must always be protected from moisture, both during transport and in storage. Ravelli recommends using a pellet with a diameter of 6 mm for the stove.

4. The Components of the Stove

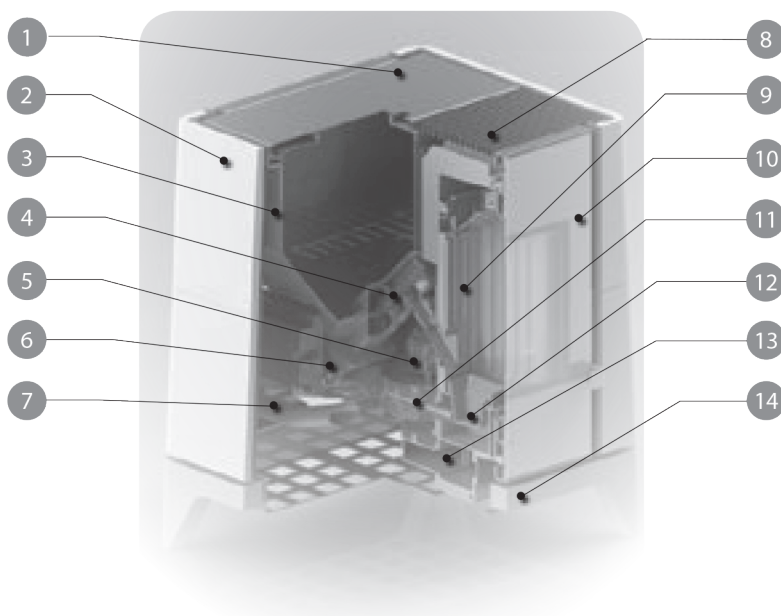

- 1 Pellet tank cover
- 2 Design coating
- 3 Pellet tank
- 4 Pellet infeed screw
- 5 Smoke extractor
- 6 Pellet gear motor
- 7 Air intake duct with flow meter
- 8 Hot air output grid
- 9 Vermiculite
- 10 Front door
- 11 Ignition resistance
- 12 Cast iron brazier
- 13 Fume duct
- 14 Stove base
- 15 Air intake duct with flow meter

4.1 Pellet Combustion

Combustion is simply a chemical reaction between combustible and carburant. The result of this reaction is the heat.

The three elements that are required for combustion are:

- Combustible (pellet)
- Carburant (oxygen available in the air)
- Ignition (electrical resistance for ignition)

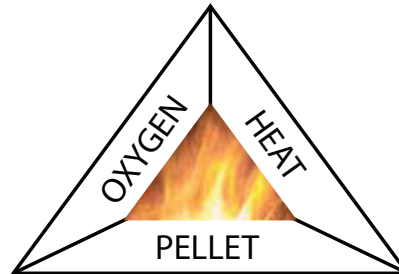

To achieve combustion, the combustible and the carburant must be available in the correct proportions.

The reaction between combustible and carburant is made by an external starter. Ignition can be created by direct contact with a heat source, or by a spark. Incorect combustion is evident when the flame is too tight, and there are too many incandescent pellets in the firepot.



INCORRECT combustion - the flame is weak and there are a lot of unburned pellets in the firepot. Check first that the ash pan is properly closed. Then adjust set pellet/air increasing the air percentage (from 0 up to +5). If this doesn't work, try increasing the loading quantity of the pellet (from 0 up to -5) to reach the flame condition shown in picture 3.

If with the adjustments done, the flame is not reaching the condition shown in picture 3, contact After Sales Service.



The combustion is **NOT CORRECT**, the flame is weak and a lot of unburned pellet wood in the firepot. Check first that the ash pan is properly closed. Then adjust set pellet/air increasing the air percentage (from 0 up to +5); in the event this is not enough, increase the loading quantity of the pellet (from 0 up to -5) to reach the flame condition shown in picture 3.

If with the adjustments done, the flame is not reaching the condition shown in picture 3, contact After Sales Service.



The combustion **IS CORRECT**, full flame, yellow/white, and minimum quantity of pellet in the firepot.

The combustion is fine, and no ash.

The picture 3 shows a flame with a stove working at power P5.

5. Maintenance and Cleaning

Before carrying out any maintenance, take the following precautions:

- Make sure that the stove has been turned off, and that the general power supply has been disconnected (Ensure that the plug is disconnected from the socket, thus avoiding accidental electric shocks).
- Make sure that all parts of the pellet stove are cold.
- Make sure that the ashes have cooled completely.
- Make sure that the general switch is in the zero position (off).
- Always use appropriate tools for maintenance.
- When you have finished, re-install all safety guards before using the pellet stove again.

The pellet stove requires little maintenance if quality wood pellets are used, which is why we recommend pellet fuel that is manufactured to the AS/NZS4014.6.

5.1 Cleaning the surfaces

To clean the surfaces on the painted metal parts, use a damp cloth.

Important: the use of aggressive detergents or abrasive cleaners can damage the surfaces of the stove.

5.2 Automatic cleaning system

The main characteristic of this model is the automatic cleaning of the firepot. Consequently there is no more need to clean the firepot periodically or at every start of the stove.

Cleaner working (rotation 360°)

Ash-drawer: ashes are released underneath the firepot

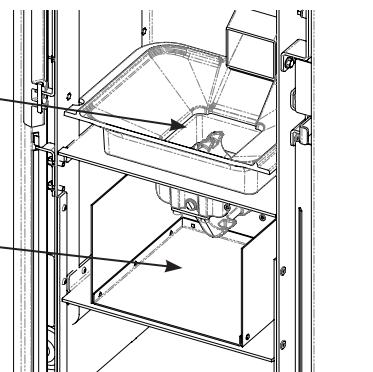

Cleaning the ash pan:

The cleaner sets every time the stove is turned on (2 rotations by default) and after 8 hours working (default value). The timing for this operation (work/cleaning/restart) takes about 10 minutes without affecting the heat exchange in the room, being its parts in cast iron.

Pull out the drawer from the stove and remove the ash using a special vacuum cleaner; be very careful to the brazier, it may still be hot and may damage the equipment used for cleaning.

Cleaning operations of the stove depend on the quality of the pellets used and the frequency of use. It may be necessary to carry out these operations on a daily basis.



Ash pan that needs to be emptied

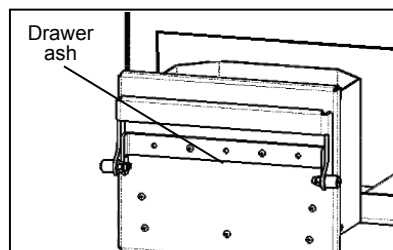

Cleaning glass

The glass of the door should be cleaned with the stove cooled down using a cotton cloth or paper towel.

Usually, we recommend you clean the glass with a damp (water) cloth and ash collected after burning (having an abrasive function).

5.3 Cleaning the Ashes Draw

The ashes drawer must be cleaned every 2 days, depending on the length of time the stove is used, and the type of pellet used. To access the drawer, open the door (see figure 1) and extract the ashes drawer (see figure 2)

N.B.: The operation must be carried out when the stove is cold, using a drum-type vacuum cleaner.

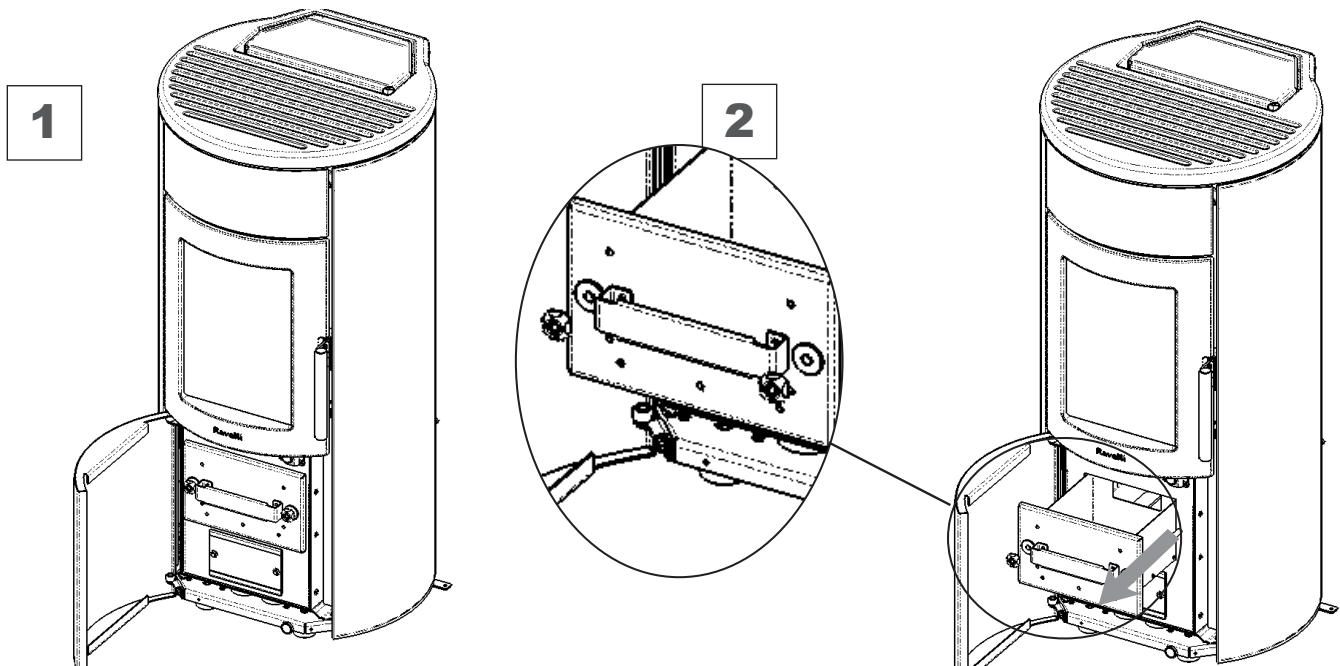

The pellet stove is a generator of heat, with a solid fuel, and as such requires servicing by qualified personnel at least once a year at the start of the season. This maintenance has the purpose of ascertaining and ensuring the efficiency and safety of all the components.

We recommend you draw up an annual contract for maintenance of the product with your installer/dealer.

5.4 Cleaning the combustion chamber

The stove requires simple but frequent cleaning to guarantee an efficient yield and correct functioning. Therefore, clean the combustion chamber every day using a drum-type vacuum cleaner, making sure that the ashes are cold first.

5.5 Cleaning the Flue

The flue will require cleaning only once each winter (or every 1000 hours) providing that the correct fuel is used. You should arrange for this when booking your annual service with your local Pellet Fire Solutions Service Agent. Use a drum type vacuum cleaner only.

5.6 Access to the inspection hatches for cleaning the smoke

Remove the side panels and release the two screws that secure the hatches to the body of the pellet stove. Clean the inside using a drum type vacuum cleaner.

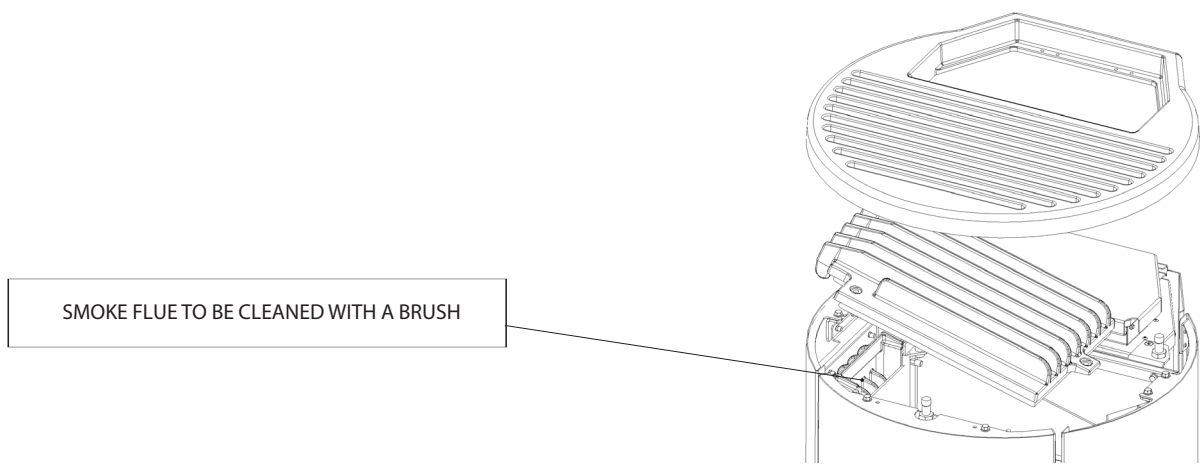

1

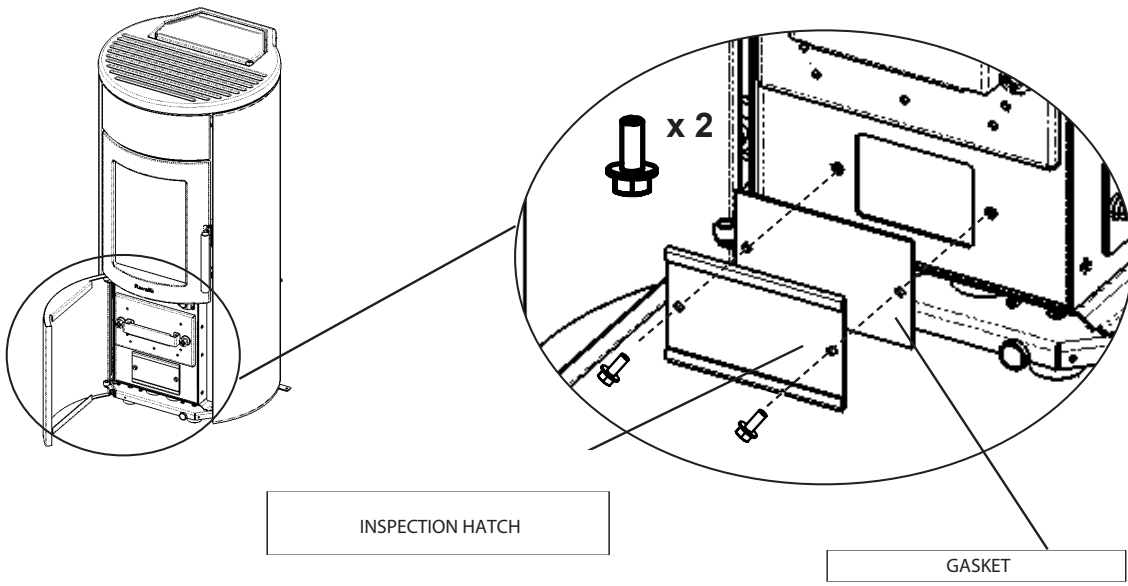

5.7 Frequency of Component Cleaning

| Parts/Frequency | Daily | 2-3 Days | 30 Days | Yearly | Performed By |
|--------------------|-------|----------|---------|--------|--------------|
| Burn pot | • | | | | Owner |
| Ash Drawer | | • | | | Owner |
| Glass | | • | | | Owner |
| Flu | | | | • | Technician |
| Door gasket | | | | • | Technician |
| Combustion chamber | | | • | | Owner |
| Vacuum Hopper | | | • | | Owner |
| Clean T discharge | | | | • | Technician |

5.8 How to load pellet

open the lid of pellet tank (1) and lift the iron slide (2) as shown. This helps to prevent the pellet bag to touch the cast-iron parts.

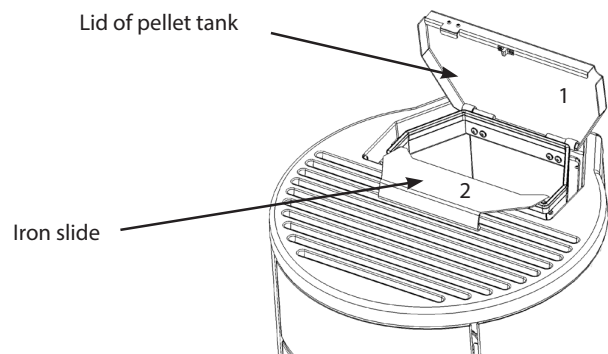

5.9 How to remove flame trap

Remove and clean the flame trap regularly

Fase A / Phase A

Fase B / Phase B

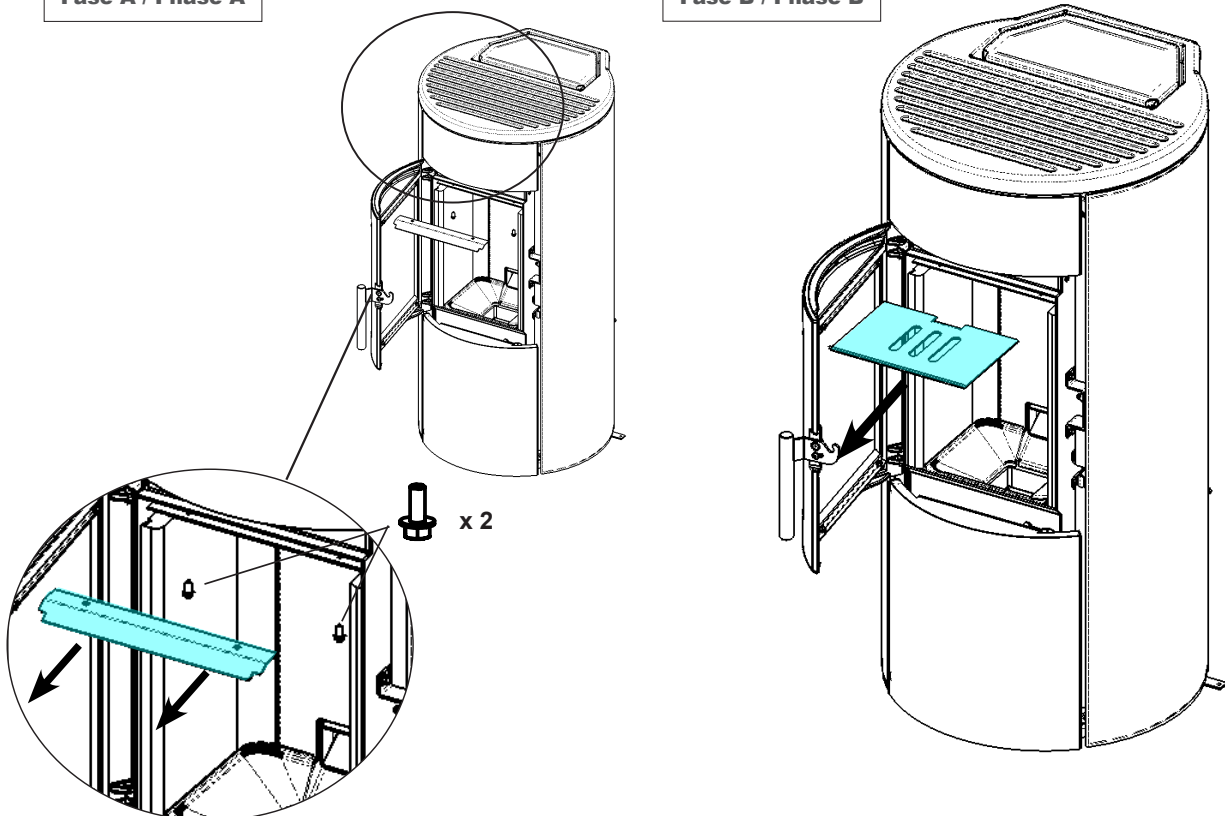

6. Operating your Pellet Fire

6.1 Preliminary Operations

Wiring



Connect the power cord to the back of the stove and then to a wall socket. The I/O switch in the figure should be set to I to power the stove. If voltage is not supplied check the state of the fuse installed in the box below the switch (4A fuse). During the periods of inactivity, we recommend you disconnect the power cord of the stove.

What to check before turning on the stove

Make sure you have removed all parts that pose the risk of burns from the combustion chamber or glass (various instructions or stickers).

Before turning on the stove, make sure you have fitted the grate on the support base and check that the door and the ash drawer are properly close.

How to load the pellets

Fuel supply consists in the insertion of pellets from the top of the stove, by opening the door. During pellet loading prevent the pellet bag from coming into contact with hot surfaces.



NEVER INSERT INTO THE TANK OTHER KIND OF FUEL OTHER FROM THE PELLETS
COMPLYING WITH THE SPECIFICATIONS BELOW

6.2 Description of the handheld set:

The handheld set is shown in the picture below:

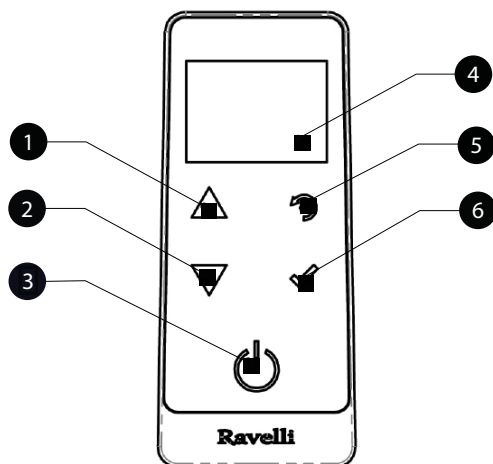

- 1 Increase button "UP" (selection key)
- 2 Decrease key "DOWN" (selection key)
- 3 ON/OFF or reset from "Sleep" mode key.
- 4 Display
- 5 Key for accessing the MENU and back
- 6 Confirmation key



In "Sleep" mode, the handheld set screen is obscured, keeping however active the radio communication with the stove to reduce battery consumption.

The information below will allow you to become familiar with the product and achieve the best performance.

How to insert the batteries in the handheld set:

Remove the protective cover of the battery on the back of the remote control as shown in Figure A, and insert the 3 batteries (mini pen style battery AAA 1.5V) in the housing of the handheld set and observe the poles. Install the battery protective cover as shown in figure B

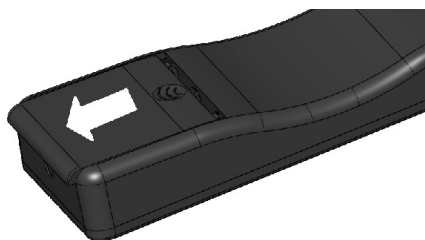
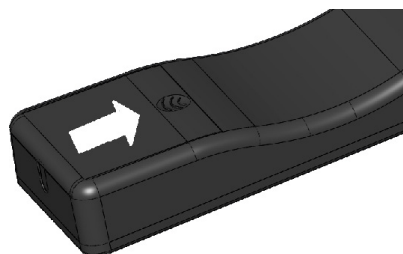

Figure A



The handheld set, after a short screen showing the Ravelli logo, will list the languages available in the menu.

ITALIANO
DEUTSCH
ENGLISH
FRANCAIS
DANSK
NEDERLANDS
ESPANICE

Select the desired language using the scroll keys and confirm your selection with the confirmation button.

6.3 Handheld touch radio initialization

In order to operate correctly, the handheld set should be interfaced with the electronic board installed inside the stove. For this reason, on display appears the following message:



If the handheld set is used for the first time, select **YES** using the selection keys and confirm with the dedicated key.

On the display of the handheld set appears the following:

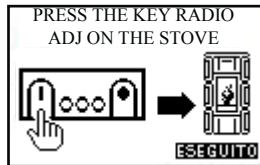

Hold down for a few seconds the button of radio communication (RADIO ADJ) of the PCB, located on the back of the stove, to initialize the device.

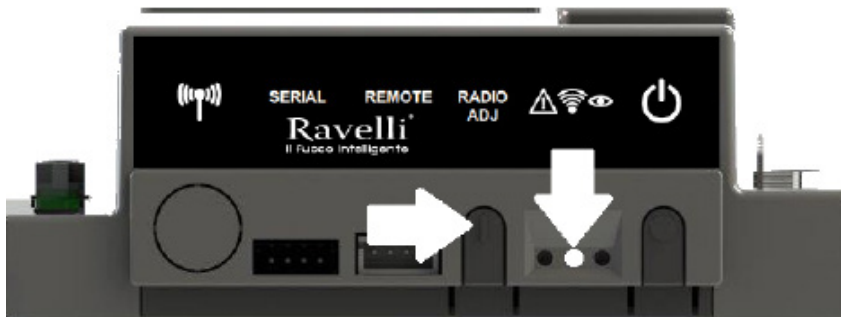

The flashing yellow LED indicates that the circuit board is waiting to receive the signal from the handheld set.

By pressing the enter key on the handheld set, the components start communicating with each other. A check sign on the display, accompanied by a sound signal, shows that the initialization of the handheld set has been completed successfully.



 *When you replace the batteries, you do not have to run the initialization procedure of the handheld set. In this case, when on display appears the message "FIRST INSTALLATION ?", select **NO** and press the confirmation key.*

6.4 Description of the display

The display of the handheld set is described below (in stand-by mode):

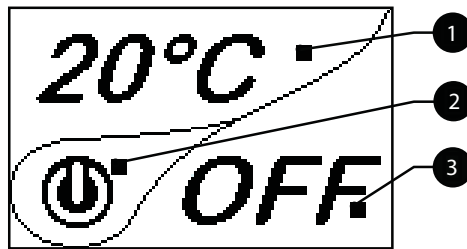

i After 5 minutes of inactivity, the display of the handheld set turns dark, switching to "SLEEP" mode, while maintaining the radio connection with the stove. By pressing the key ON/OFF, the display becomes active again.

i The first press of any key with the display active, lights up its backlight, but it is not, however, considered a command.

The display is subdivided into three parts:

- 1 It shows the current room temperature measured by the handheld set. Moreover, if you press the DOWN scroll key you will display the temperature settings that can be changed using the two UP/DOWN keys. Any change made is confirmed automatically within 3 seconds from the change or by pressing the confirmation key. A sound signal indicates that the change has been confirmed.



- 2 In the inactive phases (combined with the 3rd part of the display) indicates the state of the stove. In the active phases, it indicates the operating power of the stove. In addition, by pressing the DOWN scroll button, you can display the power settings, that can be edited using the two scroll keys
UP/DOWN: The confirmation of any change takes place automatically within 3 seconds from the change or by pressing the confirmation key. A sound signal indicates that the change has been confirmed.



6.5 Time and date setting

Below are given the steps for accessing the relative menu.

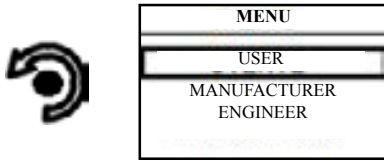

Press the key "access menu" to access the MENU page

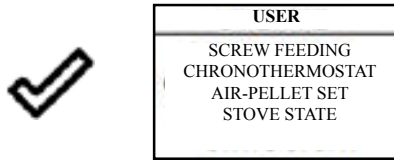

Press the key "confirm" to access the USER page

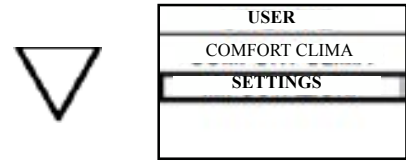

Press the key "selection" for "selection" to switch to the second page of USER MENU and select SETTINGS.

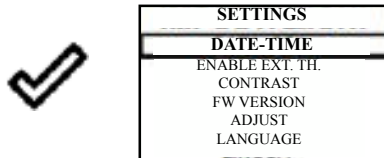

Press the key "confirm" to access the SETTINGS page

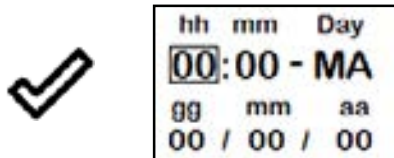

Press the key "confirm" to access the page DATE-TIME



Press the increase key to change every single value



Press the decrease key to change every single value



Press "confirm" to confirm the settings and switch to the next value.



By pressing the key "back" for several times you will display the stand-by page.

6.6 Loading the Auger



Carry out this operation to facilitate stove's first start operations; You should also check that you have introduced pellets into the hopper and wait until the stove is in "SHUTDOWN" or "FINAL CLEANING" mode. The number expressed in seconds indicates the rotation time of the infeed screw during the first loading cycle. Once this time has elapsed, the infeed screw stops immediately and then pellets are emptied from the grate before turning on the equipment.

Below are given the steps for accessing the relative menu.

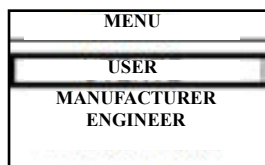

Press the key "access menu" to access the MENU page



Press the key "confirm" to access the USER page

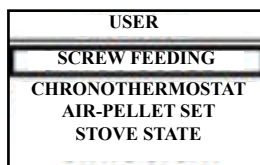

Press CONFIRM to enable the rotation of the auger



At the end of the auger loading, the display shows 0 "and automatically switches to the USER menu page.



Press the key for several times until the Stand-by page is displayed.



ALWAYS EMPTY THE BRAZIER BEFORE TURNING THE STOVE ON AND ALWAYS CHECK THAT ALL NONE OF ITS HOLES IS CLOGGED NEVER EMPTY THE RBAZIER INSIDE THE HOPPER. FIRE HAZARD.

6.7 Setting Operating Temperature and Power

Set the two values following the indications given in the chapter "Description of the display"

6.8 Turning the device on

Keep the key ON/OFF pressed for a few seconds to turn on the stove.



The appearance of the message "ADJUST THE RDS SYSTEM" indicates that the initial parameter testing procedure and calibration has been unsuccessfully. This indication does not cause stove blockage (see the SIGNALLING POP UP section).

On the display of the handheld set appears the following:

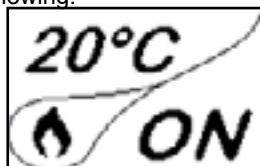

Press and hold the ON/OFF button to turn off the stove door, and reset any alarms triggered.



In case the infeed screw operations described above have not been executed, the stove may fail to turn on. In this case, carry out the operations described above and empty the brazier and reset the alarm.

If the stove still fails to turn on, check that the grate is properly installed and perfectly adherent to the base, and also check that there are no deposits that prevent the smooth passage of air to enable ignition. If the problem persists, contact the support service.

Sequence of ignition phases



SWITCH-ON- initial pellet loading phase; WAIT FLAME - flame development wait phase;

FLAME PRESENT - flame stabilization phase and reduction of combustible inside the brazier;



WORK - operation phase described in the dedicated chapter;

What happens if the batteries are empty?



If the battery is discharged, within the "drop" is shown a symbol that indicates that the battery is empty, while maintaining active the features of your device.



As soon as the level of the battery prevents the radio communication the handheld set displays on full screen the picture of empty battery and all device functions are locked until the batteries are replaced

6.9 Operating Phases of the Stove

Modulation

During the work phase, the appliance should reach the room temperature set; when this condition is met, the stove switches to MODULATION mode in which fuel consumption and ventilation are minimum.



If you wish to detect the ambient temperature by means of an external thermostat (optional), this must be connected to the appropriate connector on the rear side of the stove; and you will have to activate the reading in "SETTINGS - ENABLE THERMOSTAT." On display appears the writing TON / TOFF based on thermostat request.



CONNECT AN EXTERNAL THERMOSTAT WITH A SIMPLE DRY CONTACT, THEREFORE, NOT POWERED. MOREOVER, WE RECOMMEND YOU USE A THERMOSTAT WITH A MINIMUM OFFSET OF 3°C IF YOU INTEND TO USE THE COMFORT CLIMA FUNCTION.

Comfort climate

The activation of this function enables the stove to reduce pellet consumption by activating the modulation phases, after the desired temperature has been reached. Subsequently, the stove checks that the temperature is maintained steady for a preset time. If this condition is met, it automatically switches off, and on display appears the writing ECO. The stove turns on again when the temperature drops below the set threshold.

Below are given the steps for accessing the relative menu.



Press the key "access menu" to access the MENU page

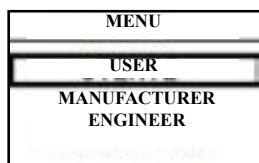

Press the key "confirm" to access the USER page

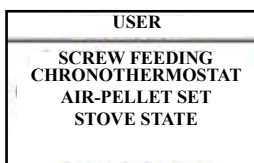

Press the key "selection" for "selection" to switch to the second page of USER MENU and select CLIMATE COMFORT.

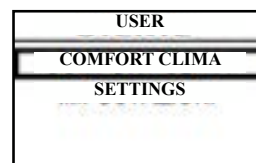

Once you have accessed the Climate Comfort menu, it is possible to operate on the 3 types of settings dedicated to the function:

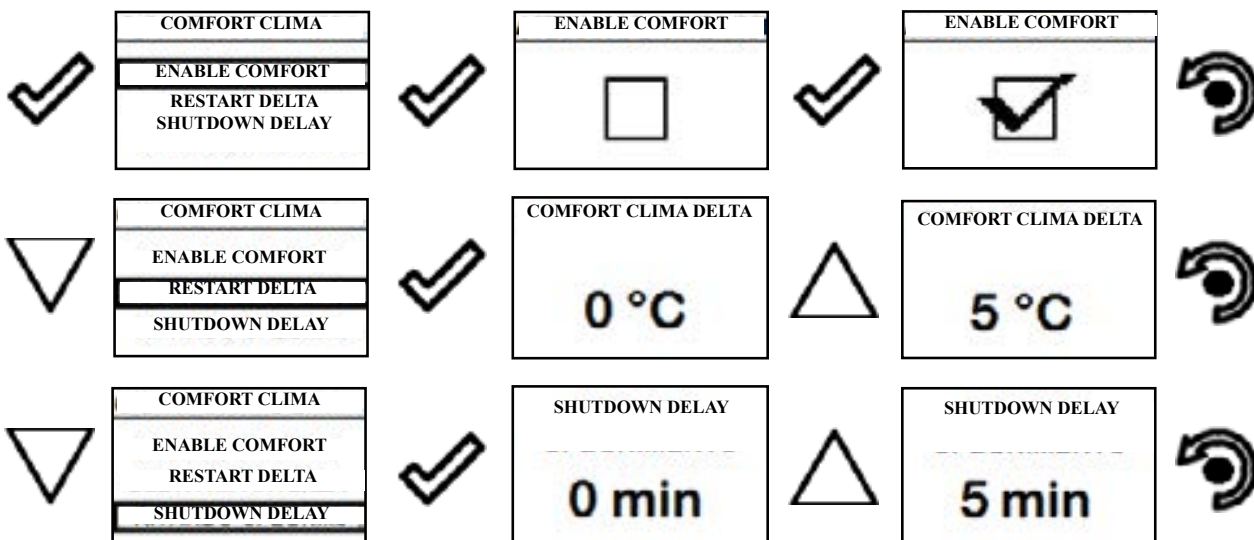

Press the key for several times until the Stand-by page is displayed.

The first setting allows the activation of the CLIMATE COMFORT function. This function is intended to ensure that the room temperature set is maintained steady upon setting the maximum period of "X" minutes (SWITCH-OFF DELAY: 5 MIN) before switching to ECO STOP phase. The STOVE maintains this state until the temperature drops below the set value (CLIMATE COMFORT DELTA : 5°C).

For example, with the room temperature at 21 °C, the stove switches off when this temperature is reached and restarts when the temperature reaches 15°C (21°C - 5°C - 0,5°C tolerance).

You can also activate the function using an external thermostat, keeping in mind that this does not include the value of the hysteresis.



We recommend you use an external thermostat with a hysteresis value that can be set to maximum 3°C. The operation of the stove could activate the switch ON/OFF phases for several times during the day; this may affect the service life of the ignition coil.



USING THIS METHOD, IT IS NECESSARY TO VERIFY THAT AFTER EACH AUTOMATIC SHUTDOWN THE GRATE IS ALWAYS VERY CLEAN TO GUARANTEE CORRECT AUTOMATIC SWITCH ON.

Description of menu functions



Press the key to access the MENU page

| |
|--------------|
| MENU |
| USER |
| MANUFACTURER |
| ENGINEER |



The TECHNICIAN and MANUFACTURER menus are protected by password.

Chronothermostat

With the Chrono-thermostat function you can program the automatic switch ON/OFF of the stove for each day of the week for each day of the week in 4 independent time intervals (SET CHRONO 1-2-3-4)

Below are given the steps for accessing the relative menu starting from Stand-By mode.



| |
|--------------|
| MENU |
| USER |
| MANUFACTURER |
| ENGINEER |

Press the key "access menu" to access the MENU page



Press the key "confirm" to access the USER page

| |
|------------------|
| USER |
| SCREW FEEDING |
| CHRONOTHERMOSTAT |
| AIR-PELLET SET |
| STOVE STATE |



Press the key "selection" to quickly switch to CRONO-THERMOSTAT.

| |
|------------------|
| USER |
| SCREW FEEDING |
| CHRONOTHERMOSTAT |
| AIR-PELLET SET |
| STOVE STATE |



| |
|---------------|
| CHRONO |
| ENABLE CHRONO |
| SET CHRONO 1 |
| SET CHRONO 2 |
| SET CHRONO 3 |
| SET CHRONO 4 |



| |
|--------------------------|
| ENABLE CHRONO |
| <input type="checkbox"/> |



| |
|-------------------------------------|
| ENABLE CHRONO |
| <input checked="" type="checkbox"/> |



| |
|---------------|
| CHRONO |
| ENABLE CHRONO |
| SET CHRONO 1 |
| SET CHRONO 2 |
| SET CHRONO 3 |
| SET CHRONO 4 |



| | |
|----------------------|-------|
| 00.00 | 00.00 |
| LU MA WE TH FR SA SU | 00.00 |
| 5 | 21 |

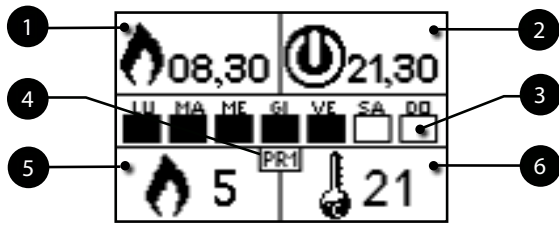

- 1 Settable switch-on program
- 2 Settable switch-off program
- 3 Day of the week with active program
- 4 Number of "chrono" program (1-2-3-4)
- 5 Setting the power upon programming
- 6 Setting ambient temperature



By pressing the Increment key you can change each value and, at step 3, enable the days of the week;



By pressing the Decrement key you can change each value and, at step 3, enable the days of the week;



Press "confirm" to confirm the settings and switch to the next value;



Press the "back" button to return to the CHRONO-THERMOSTAT page.

As per the above example, it has been set as CHRONO 1 an ignition from 08.30 to 21.30 from MONDAY to FRIDAY at the operating power 5 with a room temperature set at 21 ° C. Programmes 2-3-4 can be set in the same manner.



To exit the CHRONO-THERMOSTAT function and return to Stand-by page, press the button repeatedly.

AIR / PELLETS setting

Setting of the PELLET-FLOW mix enables you to immediately change the quantity of pellet loaded in the brazier and the air inflow. The stove is tested and inspected with DIN PLUS certified pellets. If using another type of pellets or uncertified pellets, fuel may need adjustment. Usually, the variation involves the FLOW percentage to adjust the input air and, therefore, the combustion; should the regulation of flow be insufficient, it may be necessary to also change the percentage of PELLET load.

Below are given the steps for accessing the relative menu starting from Stand-By mode.

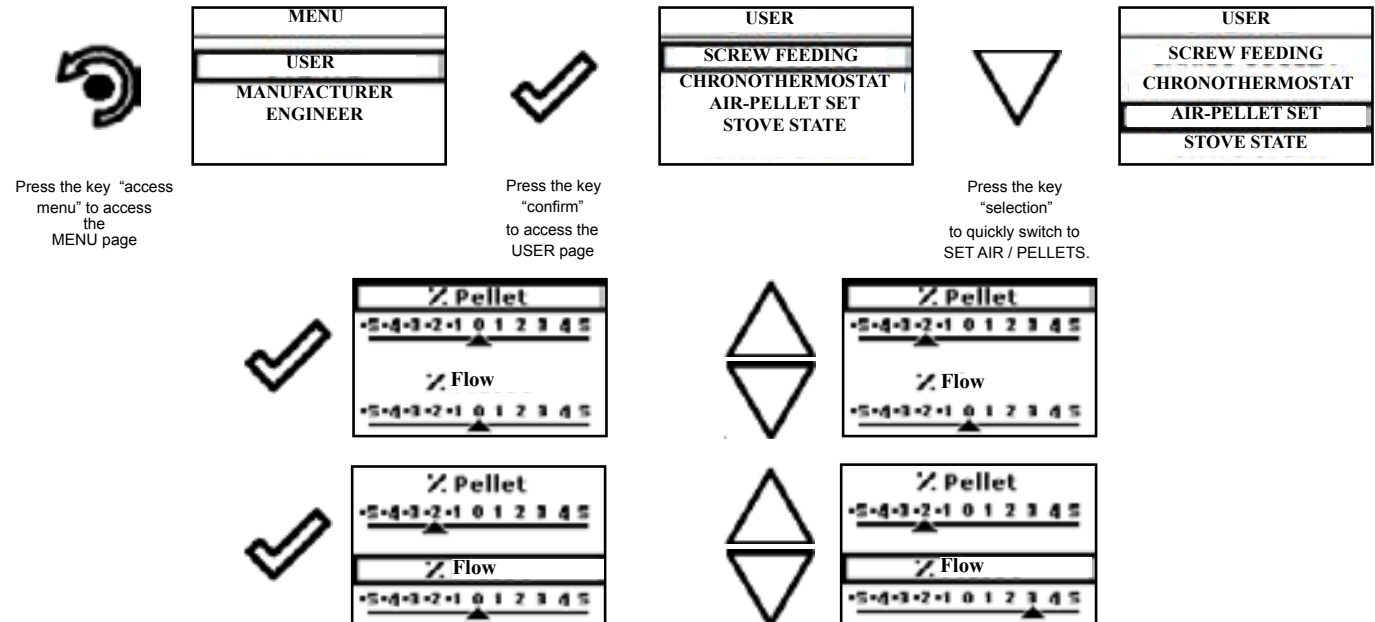

As per the above example, you have set a percentage of -2 for PELLETS and +3 for the FLOW, an indication that a setting like this is a consequence of the fact that the oxygen needed for combustion is insufficient and pellet size is smaller than the average size of 2 cm.



To exit the SET AIR - PELLET function and return to Stand-by page, press the button repeatedly.



NOTE: The number indicated during the change of parameters refers only to a percentage value that acts on the default parameters set on the electronic board (exclusively in the WORK phase). These values should be changed in the event of poor combustion, due in many cases to the purchase of pellets differing from those used during stove testing.

Stove State

Below are given the steps for accessing the relative menu starting from Stand-By mode.

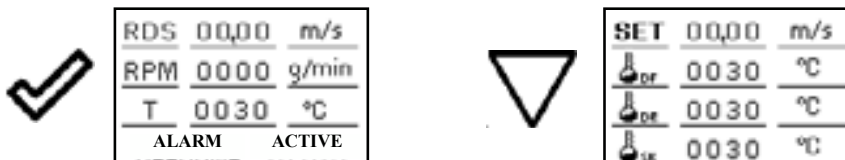
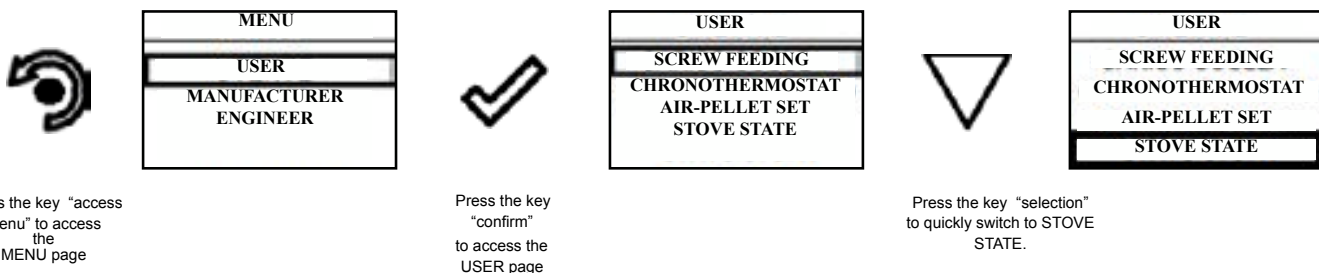

In this mode you can check the proper operation of the most important parameters of the appliance. Below is a list of real data of the stove useful for service during inspection.

- Actual flow
- Fume extractor revolutions;
- Fume temperature;
- Stove state:
- Actual flow set;
- Inlet flow meter temperature;
- Heated flow meter temp.;
- Electronic board temperature;



To exit the STOVE STATE page and return to Stand-by page, press the button repeatedly.

Settings > Enable thermostat

Below are given the steps for accessing the relative menu starting from Stand-By mode.

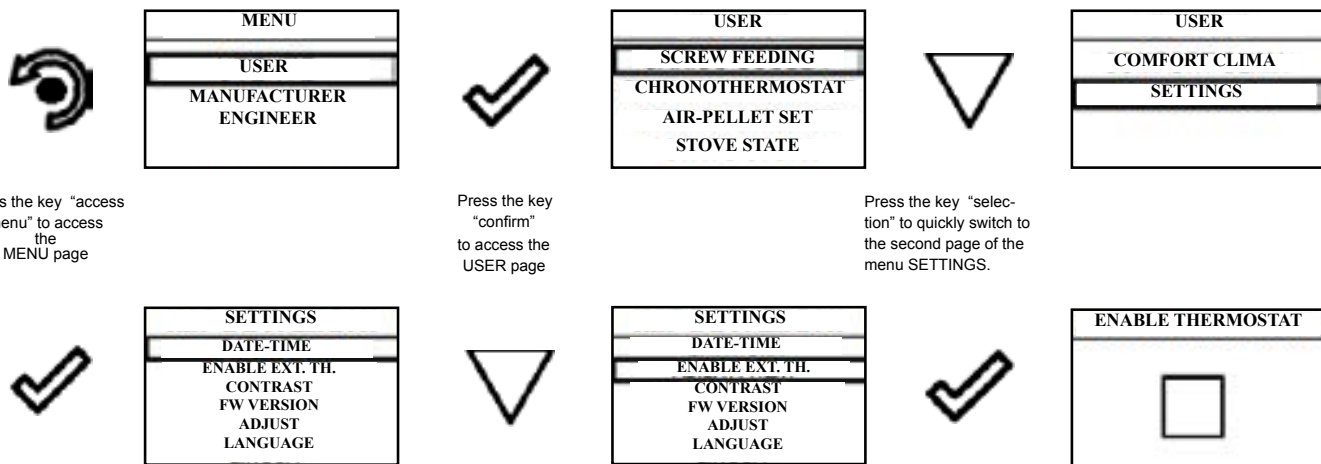

Press the key "confirm" to access the SETTINGS page

Press the key "selection" to switch to the function

Press the key "confirm" to access the function

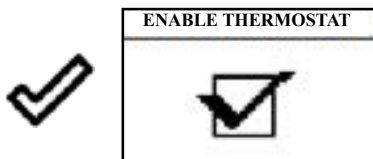

Press the key "confirm" to enable the function.



ENABLE THERMOSTAT. By repeatedly pressing the key you will go back to the "STAND BY"



In Stand-By mode, instead of the measured and settable ambient temperature appears the line T ON if the room where the thermostat is installed has not yet reached the requested value or the writing T OFF if the room temperature set has been reached.

Settings

Below are given the steps for accessing the relative menu starting from Stand-By mode.

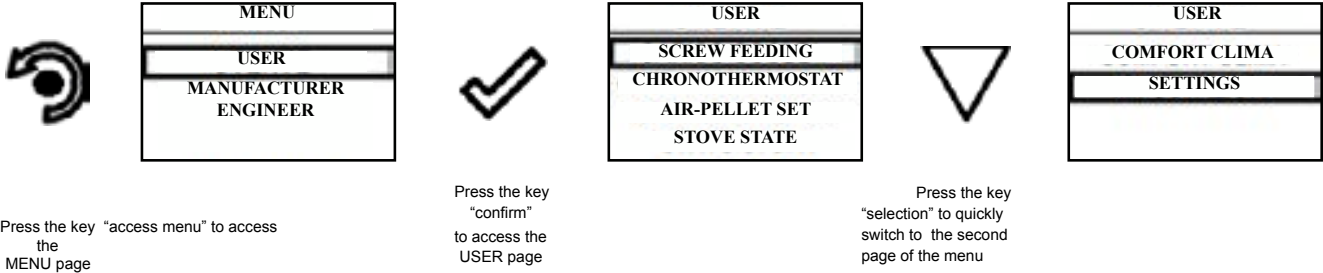

After following the procedure above step by step, you can set the following functions:

Settings > Contrast

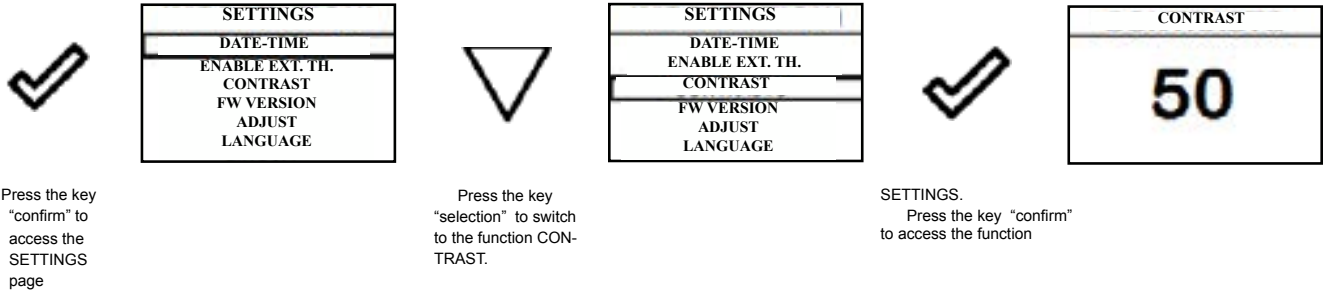

Use the UP/DOWN keys to change contrast setting and obtain a better visualisation of the information shown on the handheld set. The value can vary from 0 to 100. 50 with respect to

By pressing the following button you will confirm the data and switch to the page within the SETTINGS menu.

Settings > Firmware version

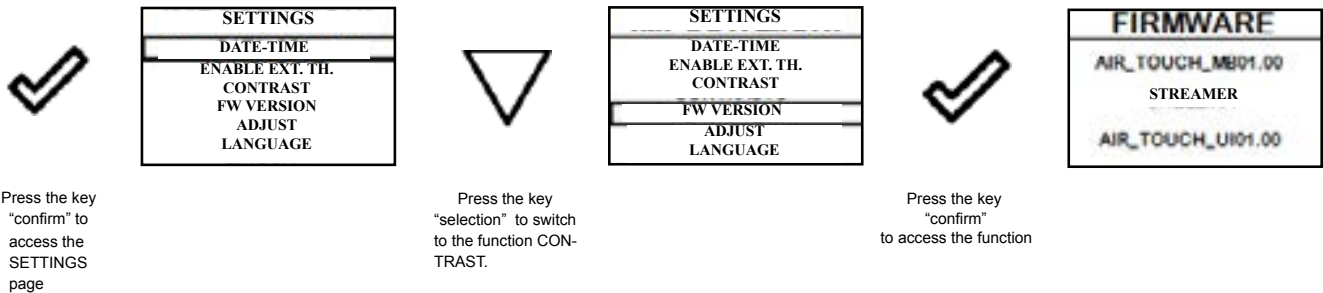

By pressing the following button you will confirm the data and switch to the page within the SETTINGS menu. SETTINGS.

Settings > Adjust

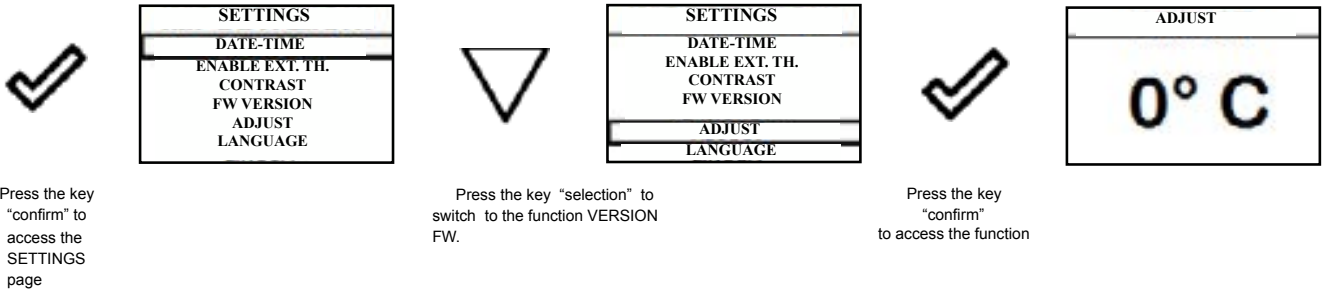

Use the UP/DOWN keys to change the value read by the room temperature probe installed inside the handheld set, with respect to a reference value. The value can vary from -10°C to 10°C.

By pressing the following button you will confirm the data and switch to the page within the SETTINGS menu.

The standard value is 0°C.

Settings > Language

To access the next setting, follow the steps given above or simply remove and replace the batteries. The device resets and prompts you again to select the language you want to set.

Single ducting (function present only in models equipped with single ducting system)

The stoves with optional fan employ the natural convection system that ensures a considerable heat output in the environment with the total absence of noise generated by room ventilation. However, the user can activate the optional fan according to the heating power needed, using the menu below.

Below are given the steps to be followed to access the relative menu from the Standby page.

Control

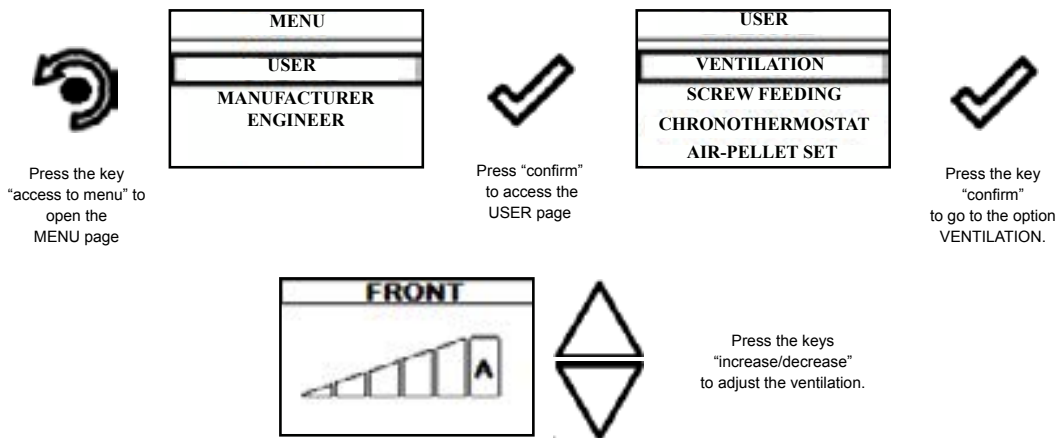

The exit key opens the VENTILATION menu again to set the other operating parameters available in the menu.

To exit the page and go back to Standby page, press the key for several times.

Control: the ventilation can be set from 0 to AUTO where 0 indicates that the same is disabled; settings from 1 to 5 enable the user to set the fan speed. If the value set is AUTO, the ventilation corresponds to the power set on the stove.

If the AUTO function is not enabled, the fan operation is not depending on stove's installed power, except for the cases in which the flame switches to modulation mode and the heat exchanger is forced to minimum.

Chrono function



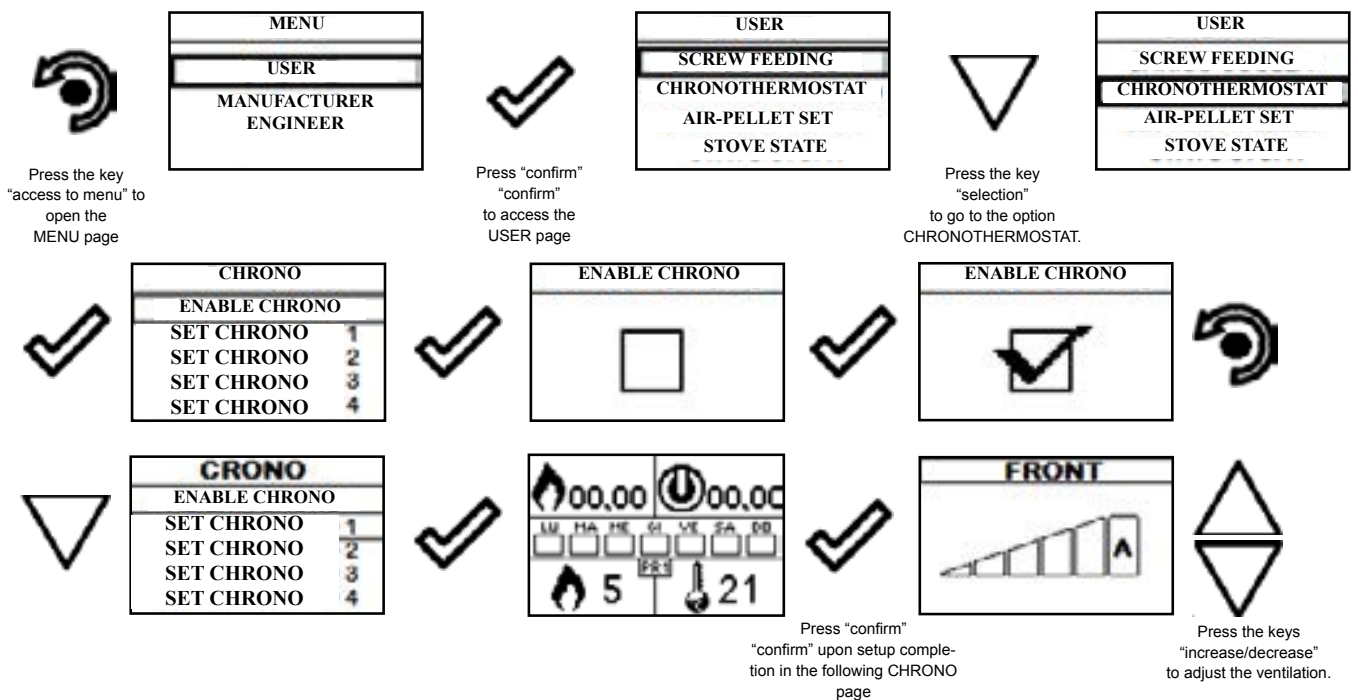



By activating the chrono function, the user can control the fan speed for each program, as shown in the logic above.







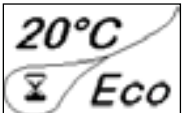

The exit key opens the CHRONO menu again to set the other operating parameters available in the menu.

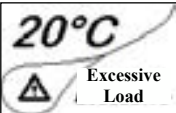
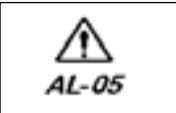

To exit the page and go back to Standby page, press the key for several times.

Stove phase synthetical layout

| | PHASE | DESCRIPTION |
|--|--------------------------|--|
|  | FINAL CLEANING | The stove is in the switch off phase and the cooling phase has not been completed yet. |
|  | SWITCH ON | The heater pre-heating phase has started and the pellets start to fall into the grate. |
|  | WAITING FOR FLAME | The pellets ignite and take advantage of the heat in the intake air that passes through the incandescent heater tube. |
|  | FLAME PRESENT | The flame is visible in the grate. |
|  | AREAS | The stove has completed the switch on phase and runs at maximum set capacity. |
|  | WORK MODULA | The room temperature set has been reached. |
|  | THE GRATE | Brazier cleaning phase is active (periodic function). |
|  | ECO STOP | With Climate Comfort active, the stove switches to automatic switch-off mode when the room temperature set is reached (see the dedicated section). |

| | PHASE | DESCRIPTION |
|---|----------------------------------|--|
|  | START/RESTART WAIT | Switch-on is requested but with the stove in cooling phase; once this condition is met, it restarts automatically. |
|  | SWITCH ON RESTART | The HOT restart phase is activated. Functioning is similar to the SWITCH ON phase |
|  | HOT SMOKE | The maximum fume temperature threshold has been reached. To facilitate cooling, the stove brings the capacity to a minimum with ventilation at power level 5, leading to a decrease in fume temperature. |
|  | OFF | The stove is off |
|  | WAIT FOR PELLETS OUT OF | When the switch-on request from ECO-STOP mode coincides with an automatic switch-off condition (from the TIMER), the stove turns on ensuring total cleaning of the brazier before switching to FINAL CLEANING. |
|  | INFEEED SCREW OVERFLOW | CONDITION: when the pellet setting (set pellets +5) is near the continuous load condition. SOLUTION: Set the value back to 0. |
|  | GENERIC ALARM | The stove is in alarm state; refer to the troubleshooting chapter. |
|  | ANOMALY (general) | The stove has detected an anomaly; refer to the troubleshooting chapter. |
|  | AUTOMATIC CLEANING SYSTEM ACTIVE | For models with semiautomatic cleaning it indicates the state of the same. |

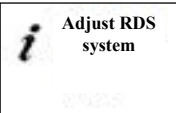
Warning Pop-Up

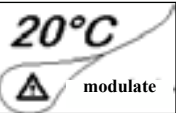
| | FLAME | DESCRIPTION |
|---|---|---|
|  | RDS SYSTEM ADJUSTMENT REQUEST (only if the RDS system is provided) | It shows that the testing procedure and initial parameter calibration have not been completed or have been performed incorrectly. This indication, however, does not block the stove. |
|  | SERVICE REQUEST | The threshold value of set work hours has been reached. The symbol displayed remains active throughout the work phase. Non-routine maintenance is required on the stove. |
|  | AIR FLOW METER FAILURE (only if the RDS system is provided) | It shows a failure of the air flow meter and the stove switches to minimum capacity disabling the RDS system. |

| SIGNALLING | REASON | SOLUTION |
|---|---|---|
| RUN BRAZIER CLEANING (only if the RDS system is provided) | • The door and the ash box are not closed correctly | • Make sure they are properly closed. |
| | • Poor combustion in grate. | • Switch off the stove, clean the brazier and check the cleanliness of the support bench, clean the tube bundle by activating the turbulators, and adjust the combustion through Pellet/Air settings. |
| | • Presence of foreign body in air intake tube. | • Check for any foreign body and remove it |
| | • The air flow meter may be dirty. | • Clean the flow meter with the stove in "Switched off" state |
| | | • Contact the Support Service |



The appearance of the message "ADJUST THE RDS SYSTEM" indicates that the initial parameter testing procedure and calibration has been unsuccessfully. This indication does not block the stove.

6.9.1 Alarms

| TRIAL | TITLE | REASON | SOLUTION |
|-------|--|--|---|
| AL 01 | BLACK OUT | - No voltage during work phase | - Press the switch off key and switch on boiler switch-on. |
| | | | - If the problem persists, contact the Support Service |
| AL 02 | FUME PROBE | - The fume probe is malfunctioning | - Contact the Support Service |
| | | - The fume probe is disconnected from the electronic board | - Contact the Support Service |
| AL 03 | FUME OVERTEMP. | - Combustion in the brazier is not optimal due to clogging or obstructions of internal stove ducts | - Switch off the stove, clean the brazier and the tube bundle and adjust the combustion setting the Pellet/Air values |
| | | - The tangential fan (if provided) is malfunctioning or damaged | - Contact the Support Service |
| | | | - If the problem persists, contact the Support Service |
| AL 04 | FUME EXHAUST DAMAGED | - Fume exhaust encoder is not working or is connected incorrectly | - Contact the Support Service |
| | | - No power to fume exhaust system | - Contact the Support Service |
| | | - The fume exhaust system is blocked | - Contact the Support Service |
| AL 05 | NO SWITCH-ON | - The pellet tank is empty | - Check for the presence of pellets in the container. Top up, if necessary. |
| | | - Pellet calibration and suction during switch on phase is incorrect. | - Contact the Support Service |
| | | - The ignition coil is faulty or positioned | - Contact the Support Service |
| AL 06 | PELLETS FINISHED | - The pellet tank is empty. | - Check for the presence of pellets in the container. Top up, if necessary. |
| | | - The gear motor is not loading pellets | - Empty the tank to see if there are any objects inside that may prevent the proper operation of the auger. |
| | | - Not enough pellets loaded | - Regulate pellets setting from "SET AIR/PELLETS" |
| | | | - If the problem persists, contact the Support Service Support |
| AL 07 | RESET THERMAL BREAKER / PELLET DOOR OR GATE OPEN | - The manual reset thermostat has tripped connected to the hopper (RESET THERMAL BREAKER / Pellet door or gate is open | - Reset the thermostat by pressing the button on the back of the stove or close the doors. |
| | | - Combustion in the grate is not optimal due to the fact that the grate is clogged or the inner stove ducts are clogged. (RESET THERMAL BREAKER) | - Switch off the stove, clean the brazier and the tube bundle and adjust the combustion setting the Pellet/Air values |
| | | | - Contact the Support Service |
| AL 08 | DEPRESSURIZATION | - The flue is blocked. | Check the flue is free and clean |
| | | - The vacuum meter is faulty. | - Contact the Support Service |
| AL 12 | FUME EXHAUST SYSTEM FAILURE | - The fume exhaust system has a loss of performance due to fan obstruction or voltage drop. | - Contact the Support Service |
| AL 14 | SCREW PHASE | - No cable connection to power the gear motor of the auger | - Contact the Support Service |
| AL 15 | AUGER TRIAC | - An internal part of the electronic board that controls the pellet infeed screw is faulty. | - Contact the Support Service |
| | | - Possible voltage drops or incorrect input voltage stove inlet | - Check the mains voltage. |
| AL 17 | NO FLOW <i>(only if the RDS system is provided)</i> | - The flow meter does not measure inlet air flow | - Check if the ash pan and door are closed correctly and check if the air inlet pipe is obstructed. |
| | | | - If the problem persists, contact the Support Service |
| AL 19 | CLEANER FAILURE <i>(for models equipped with cleaner)</i> | - The cleaner did not complete the movement and is not in the correct position | - Reset the alarm and wait for the stove to switch to SHUTDOWN mode. Cut off and power again, the system reactivates the cleaner trying to search the correct position again. |
| | | | -- If the problem persists, contact the Support Service |



In the case of alarm 07 THERMAL BREAKER below shows the location where to operate to reset the thermal switch with manual reset.

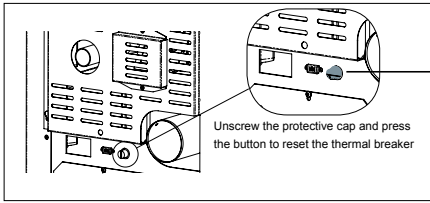

Manual reset thermal breaker



Unscrew the protective cap and press the button to reset the thermal breaker

8. Warranty Information

Pellet Fire Solutions and its partner Ravelli , manufacturers of the Ravelli range of pellet fires extends the following warranty for their wood pellet fires when purchased from an authorised Pellet Fire Solutions dealer.

8.1 Warranty Coverage

Pellet Fire Solutions warrants to the original owner of the pellet fire at the site of installation, and to any transferee taking ownership of the pellet fire at the original site of installation within two years following the date of original purchase, that the pellet fire will be free from defects in materials and workmanship at the time of manufacture. After installation, if any covered components manufactured by Ravelli are found to be defective in materials or workmanship during the applicable warranty period, Pellet Fire Solutions will, at its option, repair or replace the covered components. Pellet Fire Solutions, at its own discretion, may fully discharge all of its obligations under such warranties by replacing the product itself or refunding the verified purchase price of the product itself. The maximum amount recoverable under this warranty is limited to the purchase price of the product. This warranty is subject to conditions, exclusions and limitations as described below.

This warranty only covers pellet fires that are purchased and installed through an authorised Pellet Fire Solutions dealer or distributor. A list of authorised dealers is available on the Pellet Fire Solutions website (www.pelletfiresolutions.co.nz).

This warranty is only valid while the pellet fire remains at the site of original installation.

Contact your installing dealer for warranty service. If the installing dealer is unable to provide necessary parts, contact the nearest authorised Pellet Fire Solutions dealer or supplier. Additional service fees may apply if you are seeking warranty service from a dealer other than the dealer from whom you originally purchased the product.

Check with your dealer in advance for any costs to you when arranging a warranty call. Travel and shipping charges for parts are not covered by this warranty.

8.2 Warranty Period

Warranty coverage begins at the date of installation. In the case of new home construction, warranty coverage begins on the date of first occupancy of the dwelling, or six months after the sale of the product by an independent, authorised, Pellet Fire Solutions dealer/distributor, whichever occurs earlier. The warranty period for parts and labour for covered components is explained in the following table.

| Component(s) | Parts | Period | Comments |
|---|------------------|---------------------------------|---|
| Fireplace, stovebody and parts covering: Firebox, firebox panel, & burnpot Heat exchanger Pedestals, Panels & Legs | Full replacement | 5 years parts 2 years labour | Surface finishes, burnpot liner and ceramic panels are covered separately (see clarifications and exclusions below). |
| Electrical items covering | | | |
| Ignitor (including tube) Auger Motor Circuit Board, decal & mounting bracket Blowers (Convection and Combustion) Timers Sensors Vacuum Switch Wire harness | Full replacement | 2 years parts & labour | |
| Replacement/spare Parts | | | |
| All replacement parts beyond their original warranty period or purchased new from a Dealer | Full replacement | 1 year parts only | Evidence of the original purchase date will be required e.g. a copy of the original invoice. |
| Clarifications and exceptions | | | |
| Burnpot Liner and Brick Liner | Full replacement | 1 years parts & labour | Paint on the brick firebox lining may peel over time due to the extreme conditions and is not a flaw. |
| Exterior surface finishes (including plating, enamel or paint) | Full replacement | 1 years parts & labour | Colour changes with heating and tarnish, discolourisation and wear (including scratches, fingerprints etc.) are not covered under warranty. |
| Exclusions | | | |
| Glass | | | No warranty |
| Vermiculite (Firex 600) & ceramic panels (cast majolica) | | | No warranty |
| Fibreglass rope gaskets | | | No warranty |

8.3 Warranty Exclusions

This warranty does not cover the following:

- Changes in surface finishes as a result of normal use. As a heating appliance, some changes in colour of interior and exterior surfaces may occur. This is not a flaw and is not covered under warranty.
- Damage to printed, plated, or enamelled surfaces caused by fingerprints, accidents, misuse, scratches, melted items, or other external sources and residues left on the plated surfaces from the use of abrasive cleaners or polishes.
- Repair or replacement of parts that are subject to normal wear and tear during the warranty period. These parts include: paint, gaskets, FIREX, flame guides, and the discolouration of glass.
- Minor expansion, contraction, or movement of certain parts causing noise. These conditions are normal and complaints related to noise are not covered by this warranty.
- Damages resulting from: (1) failure to install, operate or maintain the pellet fire in accordance with the installation instructions, operating instructions and data plate furnished with the pellet fire; (2) failure to install the pellet fire in accordance with local building codes; (3) shipping or improper handling; (4) improper operation, abuse, misuse, continued operation with damaged, corroded or failed components, accident, or improperly/incorrectly performed repairs; (5) environmental conditions, inadequate ventilation, negative pressure, or drafting caused by tightly sealed constructions, insufficient make-up air supply, or handling devices such as exhaust fans or forced air furnaces or other such causes; (6) use of fuels other than those specified in the operating instructions; (7) installation or use of components not supplied with the pellet fire or any appliance not expressly authorised and approved by Pellet Fire Solutions / Ravelli; (8) modification of, interruptions to or fluctuations of the electrical power supply to the pellet fire.
- Non Pellet Fire Solutions approved venting components, hearth components or other accessories used in conjunction with the appliance.
- Any part of a pre-existing fireplace system
- Pellet Fire Solutions / Ravelli's obligation under this warranty does not extend to the pellet fires' capability to heat the desired space. Information is provided to assist the consumer and the dealer in selecting the proper appliance for the application. Consideration must be given to appliance location and configuration, environmental conditions, insulation and air tightness of the structure.

The warranty is void if:

The pellet fire has been over-fired or operated in atmospheres contaminated by chlorine, fluorine, or other damaging chemicals. Over firing can be identified by, but not limited to, warped plates or tubes, rust coloured cast iron, bubbling, cracking and discolouration of steel or enamel finishes.

The pellet fire is subjected to prolonged periods of dampness or condensation.

There is any damage to the pellet fire or other components due to water or weather damage which is the result of, but not limited to, improper chimney or venting installation.

The owner's exclusive remedy and Pellet Fire Solutions / Ravelli's sole obligation under this warranty, under any other warranty, express or implied, or in contract, tort or otherwise, shall be limited to replacement, repair, or refund, as specified above. In no event will Pellet Fire Solutions / Ravelli be liable for any incidental or consequential damages caused by defects in the appliance. Some countries do not allow exclusions or limitation of incidental or consequential damages, so these limitations may not apply to you. This warranty gives you specific rights, you may also have other rights, which vary from country to country. EXCEPT TO THE EXTENT PROVIDED BY LAW, Pellet Fire Solutions / Ravelli MAKES NO EXPRESS WARRANTIES OTHER THAN THE WARRANTY SPECIFIED HEREIN. THE DURATION OF ANY IMPLIED WARRANTY IS LIMITED TO DURATION OF THE EXPRESSED WARRANTY SPECIFIED ABOVE.

9. Proof of Purchase/Warranty

Use this page to note down the details of your wood pellet fire purchase, and attach the receipt and any other documents/ business cards from the retailer that sold you the fire.

Name of Store where Pellet fire was purchased:

Date of Purchase:

Amount Paid: \$.....

Payment Method: Credit Card EFTPOS Cash Other

Attach receipt and other documents here

Installation Section

Table of Contents

| | | |
|-----------|---|-----------|
| 1. | Dimensions Ravelli Natural 7..... | 35 |
| 1.1 | Deciding where to locate your wood pellet burning stove: | 36 |
| 1.2 | Clearances to Combustibles – Ravelli Natural 7 Freestanding | 36 |
| 1.3 | Exhaust and Fresh Air Intake Locations..... | 36 |
| 2. | Installation..... | 37 |
| 2.1 | Dimensions – Natural 7Freestanding | 37 |
| 2.2 | Clearances & Specifications | 37 |
| 2.3 | Minimum Clearance to Combustibles | 38 |
| 2.4 | Location of the Pellet Stove | 38 |
| 2.5 | Positioning the stove:..... | 38 |
| 2.6 | Location of a power source | 38 |
| 2.7 | Internal Standard Flue Kit (50SBD/N)..... | 39 |
| 2.8 | External Standard Flue Kit (51ita)..... | 40 |
| 2.9 | Seismic Restraint | 41 |
| 2.10 | Fixing to Timber Floor Framing | 41 |
| 2.11 | Installation | 41 |
| 2.12 | How to mount the side panels | 42 |
| 3. | Installation Data Sheet | 43 |
| 4. | Maintenance Record | 44 |
| | Producer Statement and Warranty Registration Form | 45 |

NOTE TO INSTALLER - PLEASE ENSURE THE “INSTALLATION DATA SHEET” ON PAGE 43 IS COMPLETED ONCE THE UNIT IS INSTALLED.

1. Dimensions (Ravelli Natural 7)



| | Unit of Measurement | |
|--|---------------------|------------|
| Height | mm | 1040 |
| Width | mm | 504 |
| Depth | mm | 561 |
| Weight | Kg | 140 |
| Diameter of smoke exhaust duct | mm | 80 |
| Min.-max.calorofic power | kW | 4.3 - 6.6 |
| Min.-max. hourly consumption of pellets | Kg/h | 0.95 – 1.5 |
| Electrical power absorbed during operation | W | 240 |
| Supply | V - Hz | 220 – 50 |
| Tank capacity | Kg | 18 |
| Space Heating Efficiency | % | 86 |

The data shown above are indicative and not binding. Ravelli reserves the right to make any modifications for the purpose of improving the performances of the product.

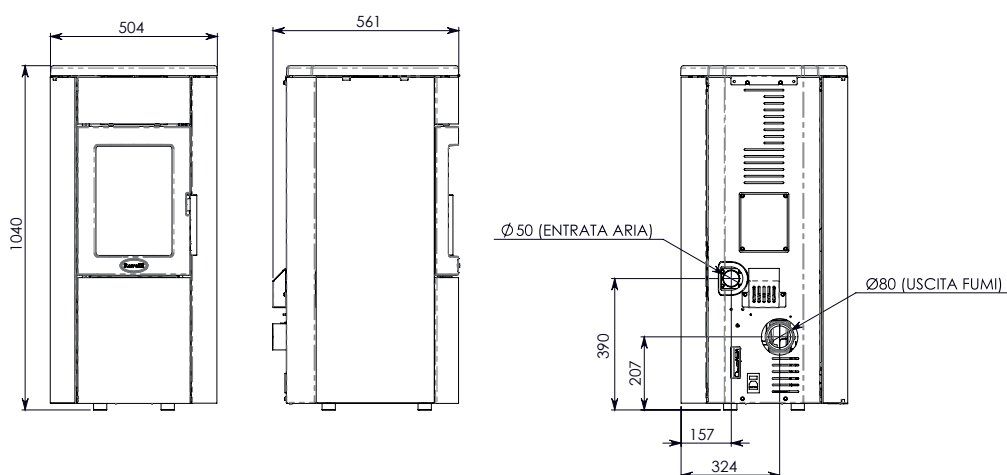

1.1 Deciding where to locate your wood pellet burning heater:

1. Do not install the pellet heater in a bedroom or room where people sleep.
2. Locate the pellet heater in a large and open room that is centrally located in the house. This will optimize heat circulation.
3. Check clearances to combustibles.

1.2 Clearances to Combustibles – Ravelli Natural 7 Freestanding

This pellet heater requires floor protection which must be non-combustible, extending beneath the stove the full width and depth of the unit including (150mm) in front for ember protection.

AS/NZS 2918:2001 states that a 300mm forward projecting and 200mm side projecting floor protector must be used from any door opening extremity as an absolute minimum. Due to the operating nature of the Natural 7 pellet heater, where opening the door causes a loss of vacuum and the fire will shut down completely, meaning the likelihood of any hot embers or burning fuel escaping from the combustion chamber is extremely minimal. Therefore a 150mm forward projecting floor protector will be sufficient.

Hearth testing of the Ravelli Natural 7 (SR 0506) showed that on exposed combustible surfaces front of the freestanding heater, no measured locations exceeded the temperature limits specified in AS/NZS 2918:2001

| | |
|---|-------|
| From the body of the heater to the side wall | 250mm |
| From the rear of the heater to wall (external flue) | 100mm |
| From the rear of unlined flue to wall (internal flue) | 75mm |
| Rear corners to wall (corner installation) | 100mm |

1.3 Exhaust and Fresh Air Intake Locations

Exhaust

| | |
|--|-------|
| Hearth to centre of exhaust outlet | 207mm |
| Side of unit to centre of exhaust outlet | 324mm |
| Centre of unit to centre of exhaust outlet | 67mm |

Fresh Air Intake

| | |
|------------------------------------|-------|
| Hearth to centre of intake | 390mm |
| Side of unit to centre of intake | 157mm |
| Centre of unit to center of intake | 100mm |

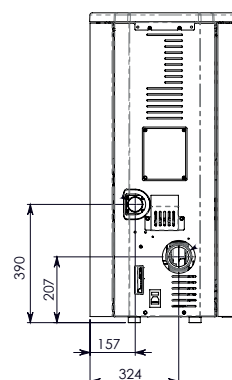

IMPORTANT

INSTALL VENT AT CLEARANCES SPECIFIED BY THE VENTING MANUFACTURER

2. Installation

2.1 Dimensions – Natural 7 Freestanding

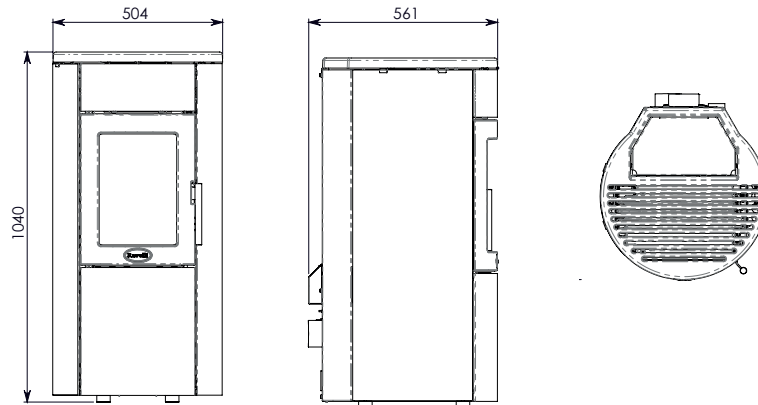

Refer to Safety Test SR 0506 for all clearances to combustibles.

2.2 Clearances & Specifications

Minimum clearances shown are in millimetres. All Ravelli fires are tested to AS/NZS 2918:2001. Specifications were correct at time of printing but may alter and those detailed below should be used as a guide only. Refer to the Installation and Operation Manual supplied with every Ravelli Pellet Fire or if in doubt, consult your Pellet Fire Solutions Retailer.

Natural 7 Pellet Fire Clearance to Combustibles

Internal Flue

External Flue

Freestanding Clearances

| Location | Dimension (mm) |
|----------|----------------|
| A | 250 |
| B | 150 |
| C* | 50 |
| D | n/a |
| E | 100 |
| F | 100 |
| G* | 50 |
| H | 100 |
| I* | 50 |
| J* | 25 |

* from shielded flue
* 75mm to unlined flue

Note: AS/NZS 2918:2001 requires a minimum of 100mm clearance for any side requiring access.

Note: These are minimum clearances to combustibles. Actual installation distances may be greater.

Note: The above clearance to combustibles on the flue are only applicable within the fire envelope. Clearance outside this e.g. at a ceiling / wall thimble reverts to 25mm as per ARS flue test 05/1185.

2.3 Minimum Clearance to Combustibles

| | |
|--|-------|
| Side of Unit (A) | 250mm |
| Rear wall to Lined Flue (C, G, I) | 25mm |
| Rear wall to Unlined Flu (C,G, I) | 75mm |
| Rear of Unit (H) | 100mm |
| Rear corners (Corner Installation) (F) | 100mm |
| Floor protection (from glass) (B) | 150mm |

2.4 Location of the Pellet Fire

Installation of the Ravelli Natural 7 Freestanding Wood Pellet Burning Heater must be undertaken by an experienced installer. Please read the Natural 7 Owners/Technical Manual thoroughly before commencing installation as failure to follow the instruction could cause damage to the pellet fire or property.

2.5 Positioning the fire:

Generally Natural 7 should be installed in a centrally located position within the home. When deciding where to position the appliance in your room you need to consider the following:

2.6 Location of a power source

- Natural 7 is a radiant heater. For optimum performance this location should be in a large room centrally located
- Natural 7 must be installed on a non-combustible surface. This surface must protrude 150mm from the front of the closed pellet fire door.
- Natural 7 has been Safety Tested to AS/NZS 2918:2001 using the Davins manufactured flue. Test Report ARS 05/1185 Installation is not exclusive to these nominated kits, though alternative flue should only be considered following consultation with your local council.
- Please see “Clearances & Specifications” for the required clearances to combustible material also ensure the position of structural elements near the proposed flue.
- Because of the positive pressure in the flue, sealing of all 75mm stainless joints is mandatory – use high temperature Maniseal. Both inner and outer flue joints must be riveted.
- Seismic Restraint: Please see “Seismic Restraint” for requirements.
- Warranty: To validate warranty following installation a copy of the completed Warranty/ Producer Statement must be forwarded to:
Pellet Fire Solutions - info@pelletfiresolutions.co.nz

50SBDNW

Internal Standard Flue Kit Dual/Natural/Whisper

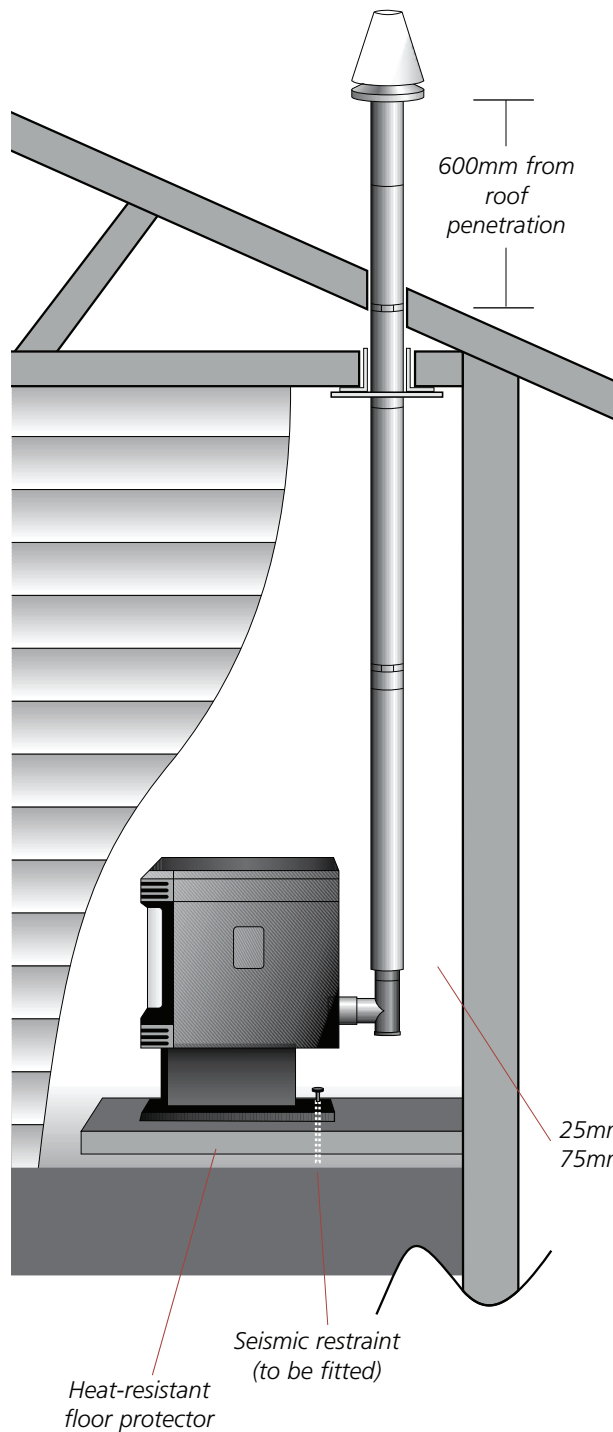

This flue kit may be used in new and replacement applications in rooms with stud height of 2.4m. The overall height of the flue is 3.6m. The visible flue is finished in black and the ceiling plate is white. The support angles for securing the liner to the ceiling are not shown. Kit is supplied in a carton.

Each 50SBDNW Internal Standard Flue Kit contains:-

| Part No | Description | Quantity |
|---------|--|----------|
| 1 | Galvanised outer liner ø100mm x 900mm long | 1 |
| 1sb | Black Stovebright outer liner ø100mm x 900mm long | 3 |
| 2 | Stainless steel inner liner ø75mm x 900mm long | 4 |
| 5 | Inner/outer flue liner spacer | 2 |
| 6c | Ceiling thimble ø107mm hole | 1 |
| 7c | Ceiling decor plate ø107mm hole – white | 1 |
| 46 | Velocity cone | 1 |
| 9 | Rain Cap 100mm | 1 |
| 81SB | T-adaptor/cleanout – black (painted) – ø75mm | 1 |
| 702 | Support angle 950mm long – 40mm x 40mm sides | 2 |

Note: The Davin 50SBDNW Internal Standard Flue Kit complies with AS/NZS 2918:2001 as per Applied Research Test Report 05/1185, dated 15 September 2005. All fires must be installed by a qualified installer as per the manufacturer's instructions and AS/NZS2918:2001.



51ita

External Standard Flue Kit

This flue kit may be used in new and replacement applications with the flue penetrating the wall behind the fire, running vertically up an outside wall and penetrating the soffit. The overall height of the flue is 3.6m. All visible flue has a galvanised finish, and can be powdercoated on request. Kit is supplied in a carton.

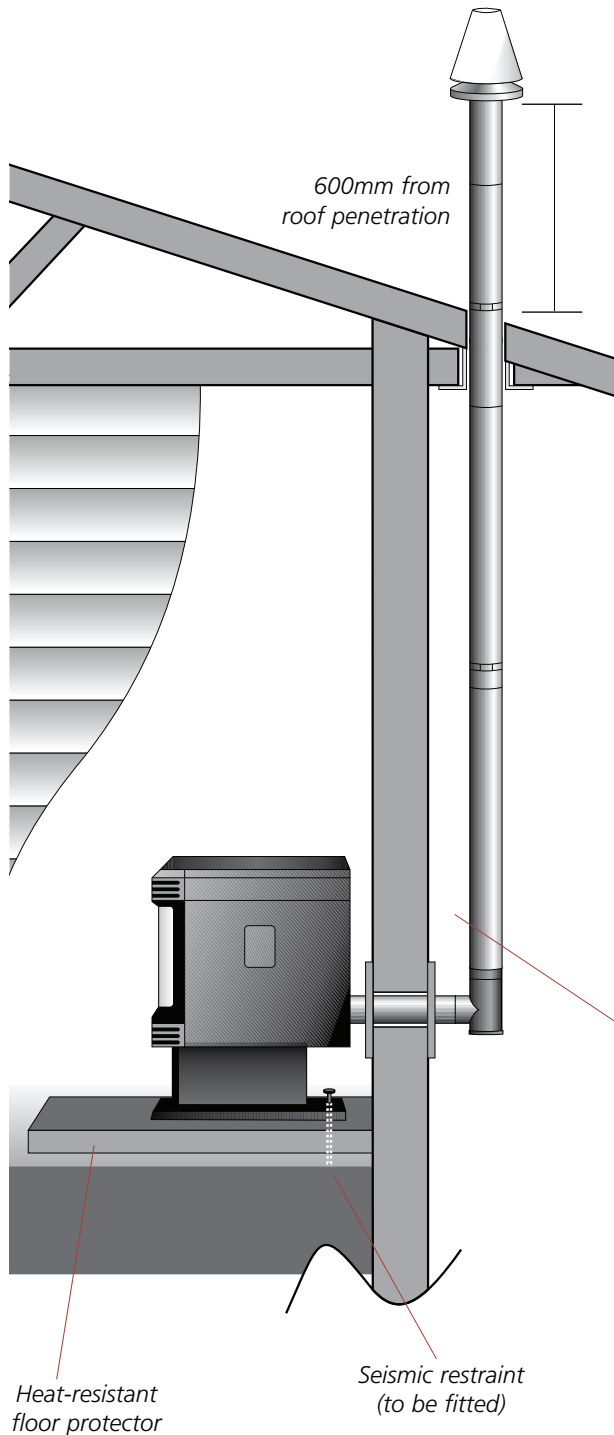

Each 51 External Standard Flue Kit (Italian) contains:-

| Part No | Description | Quantity |
|---------|---|----------|
| 1 | Galvanised outer liner ø100mm x 900mm long | 4 |
| 2 | Stainless steel inner liner ø75mm x 900mm long | 4 |
| 5 | Inner/outer flue liner spacer | 2 |
| 6w | Wall thimble – 2 pieces ø102mm holes | 1 |
| 6s | Soffit thimble ø102mm hole | 1 |
| 7w | Wall decor plate ø102mm hole – white | 1 |
| 46 | Velocity cone | 1 |
| 9 | Rain Cap 100mm | 1 |
| 26 | Lined T-adaptor | 1 |
| 73 | 76-80mm Adaptor | 1 |

25mm minimum clearance if lined:
75mm minimum clearance if unlined

Note: The Davin 51 External Standard Flue Kit complies with AS/NZS 2918:2001 as per Applied Research Test Report 05/1185, dated 15 September 2005.

All fires must be installed by a qualified installer as per the manufacturer's instructions and AS/NZS2918:2001.



2.7 Seismic Restraint

All installation scenarios for Natural 7 require the use of hold-down anchors.

Fixing to Concrete Floor:

- Minimum M8 expansion anchors (M10 recommended) or min M8 epoxy- set anchors.
- Approved Anchors: Expansion Anchors-Ramset Dynabolt and Trubolt, Hilti HAS.
- Epoxy-set Anchors – Ramset Epcon, Ramset Chemset and Hilti HVU.

2.8 Fixing to Timber Floor Framing

Minimum 14g x 60 screws (6.3mm diameter) or M10 X 90 coach-screws. These shall be fixed a minimum of 40mm into the centre-line of the existing floor joists. If screws cannot be installed directly into an existing floor joist, solid blocking between joists (min size 90x45) shall be provided.

2.9 Installation

Natural 7 should be installed in a centrally located position within the home. This will assist the appliance to perform to the level required. As Natural 7 is a radiant heater, the heater should be located centrally in the room.

Natural 7 requires a power source to function. This is standard mains feed 240v plug-if this is unavailable in close proximity a grounded extension lead may be used.

Natural 7 is to be installed on a non-combustible surface which must have a forward projection of a minimum of 150mm from the glass door.

Ensure all 75mm flue joints are sealed with a high temp silicon (Maniseal).

In accordance with the requirements of AS/NZS 2918:200. Natural 7 must be secured by seismic restraint.

2.10 Seismic Restraint Locations

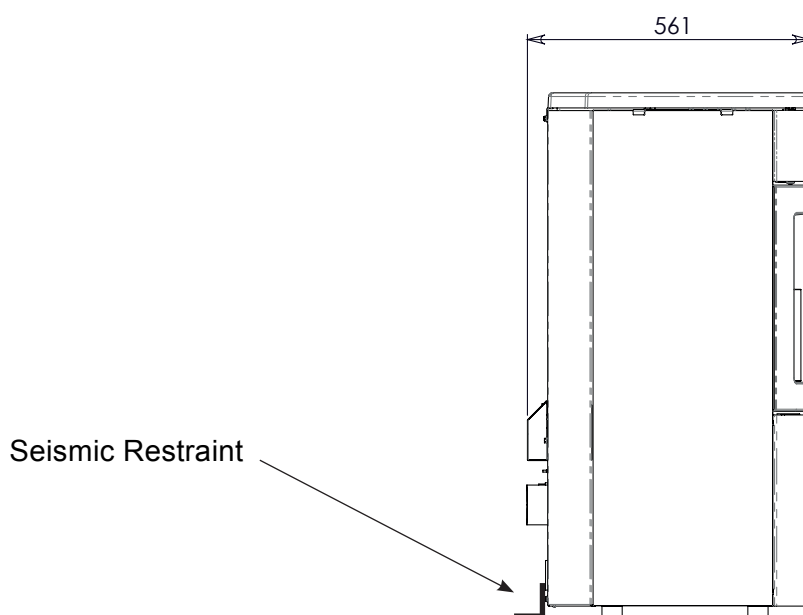

2.12 How to mount the side panels

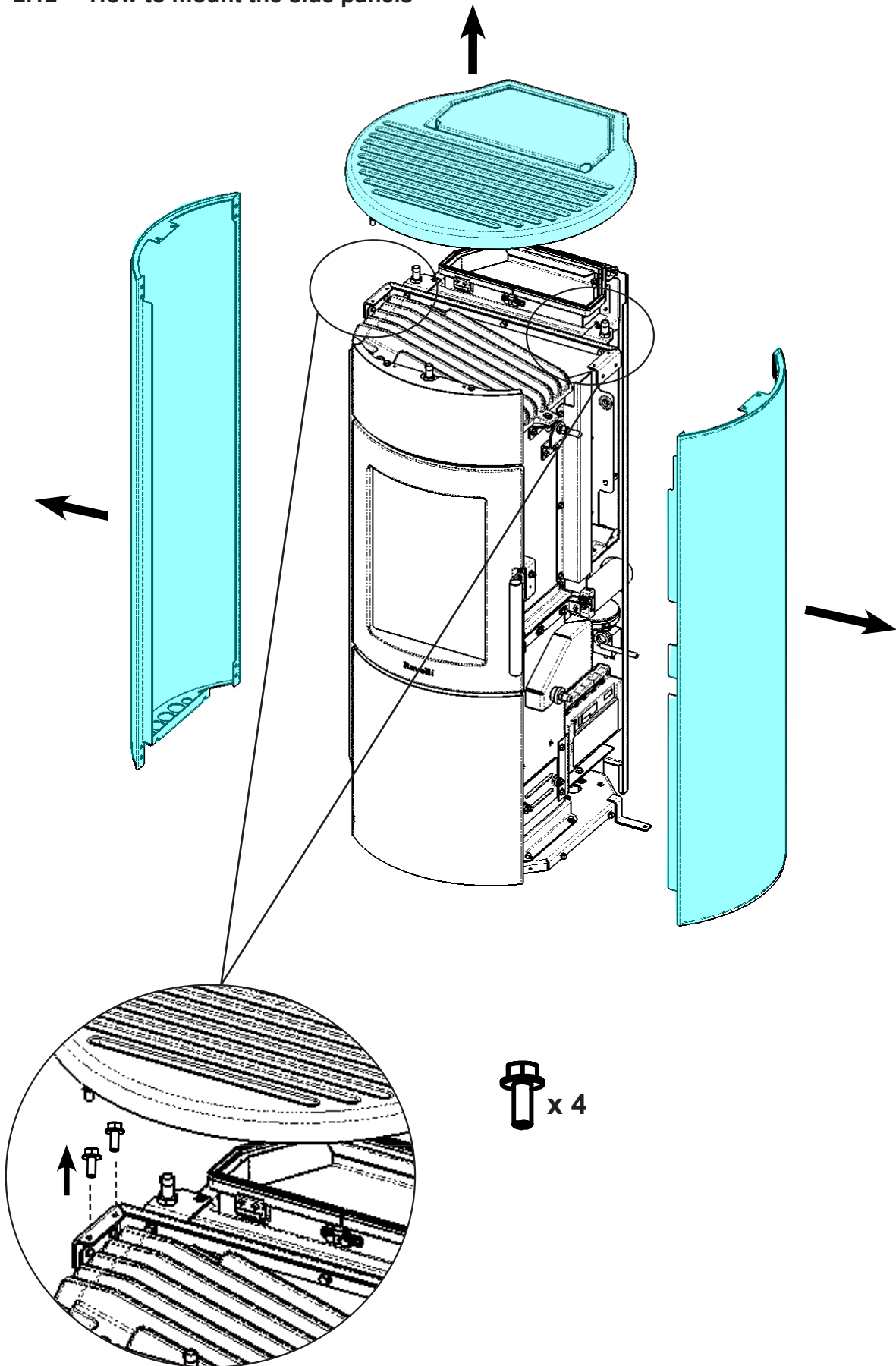

3. Installation Data Sheet

Name of Owner:

Address:

Phone:

Name of Dealer:

Address:

Phone:

Model: _____

Serial Number: _____

Date of Purchase: _____ (dd/mm/yy)

Date of Installation: _____ (dd/mm/yy)

Magnehelic at Install: _____

Installer's Signature:

Name of Installer:

Address:

Phone:

WARRANTY: If you have concerns with your unit please contact the dealer where you purchased the stove.



PRODUCER REGISTRATION FORM

This form must be completed and returned for every installation to qualify for warranty.

Post to: P O Box 11-245, Sockburn, Christchurch

Email to: info@pelletfiresolutions.co.nz

Customer Details:

Customer Name: _____

Postal Address: _____

Installation Address: _____

Phone Number

Cell Phone

Email Address

Declaration by Owner: I hereby certify the above particulars are true and correct. My Pellet Fire Technician has demonstrated to me the correct operation of my Pellet Fire.

I understand that warranty conditions require an authorised Pellet Fire Solutions Installer to complete the installation

Signed: _____

Date: _____

Installation Details:

Pellet Fire Model & Serial Number: _____

Installation Date: _____

Freestanding Flue Kit: Internal External Standard

Fireplace Insert Flue Kit: Insert BIH

Installer Details: _____

Installers Name: _____ Phone Number: _____

Passed Inspection Yes/No (if no, why) _____

Declaration by Approved Technician: I _____ hereby certify that the above appliance has been installed and commissioned in compliance with Manufacturers Installation requirements and appropriate New Zealand Standards/Local Council requirements.

Signed: _____

Date: _____